

PWP-1210  
\$20.00

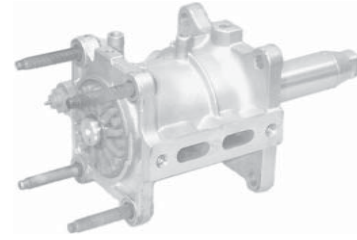

# PRECISION REBUILDERS

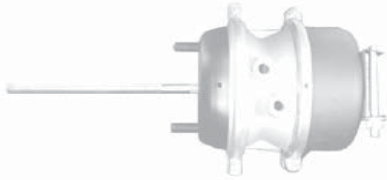

**Remanufactured  
Heavy Duty  
Engine Water Pumps**

## Other Catalogs Available

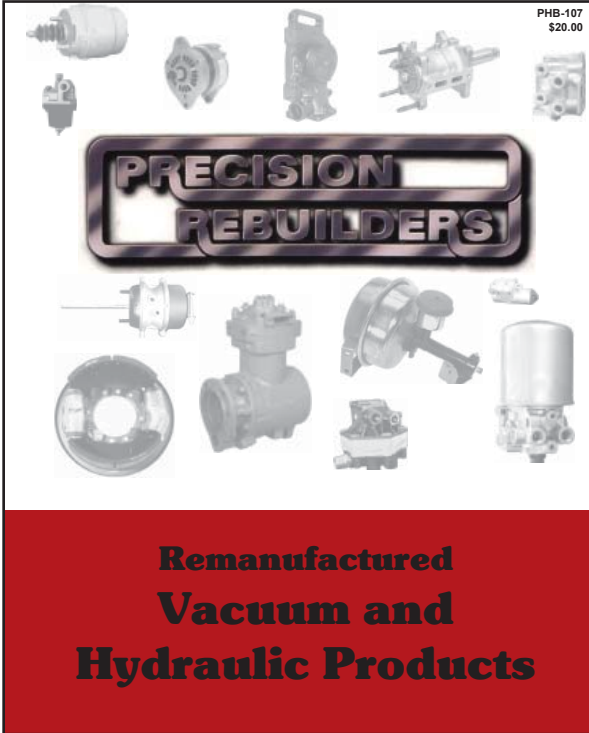

PHB-107  
\$20.00

**PRECISION REBUILDERS**

**Remanufactured Vacuum and Hydraulic Products**

This catalog cover features a central logo for 'PRECISION REBUILDERS' in a metallic, 3D-style font. Above and below the logo are various mechanical parts, including vacuum pumps, hydraulic cylinders, and valves. The bottom half of the cover is a solid red background with the product description in white text.



PAB-2010  
\$20.00

**PRECISION REBUILDERS**

**Remanufactured Heavy Duty Air Brake System Products**

This catalog cover features a central logo for 'PRECISION REBUILDERS' in a metallic, 3D-style font. Above and below the logo are various mechanical parts, including air brake components, valves, and cylinders. The bottom half of the cover is a solid light blue background with the product description in black text.

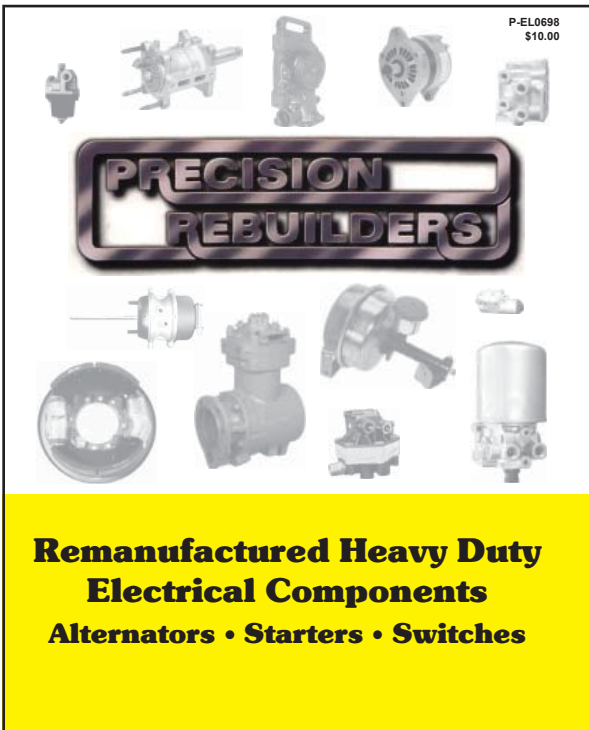

P-EL0698  
\$10.00

**PRECISION REBUILDERS**

**Remanufactured Heavy Duty Electrical Components**  
**Alternators • Starters • Switches**

This catalog cover features a central logo for 'PRECISION REBUILDERS' in a metallic, 3D-style font. Above and below the logo are various electrical components, including alternators, starters, and switches. The bottom half of the cover is a solid yellow background with the product description in black text.

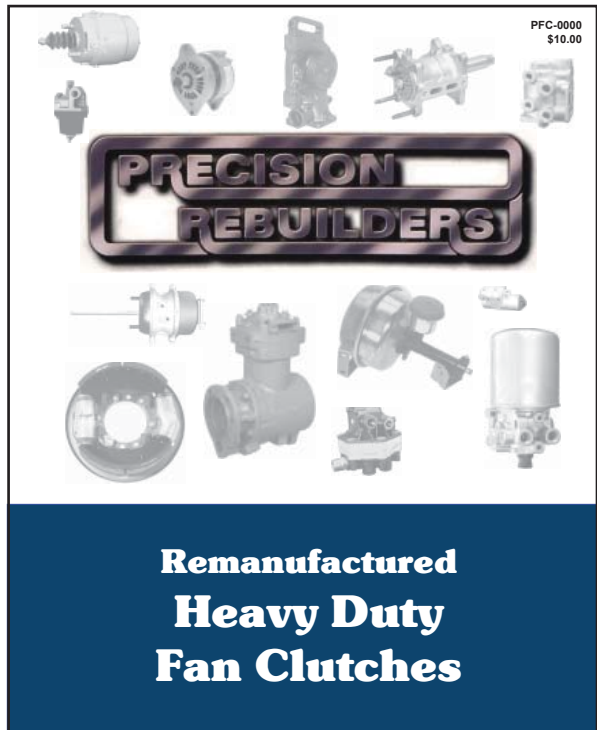

PFC-0000  
\$10.00

**PRECISION REBUILDERS**

**Remanufactured Heavy Duty Fan Clutches**

This catalog cover features a central logo for 'PRECISION REBUILDERS' in a metallic, 3D-style font. Above and below the logo are various mechanical parts, including fan clutches. The bottom half of the cover is a solid dark blue background with the product description in white text.

# SECTION 1

# APPLICATION GUIDE

## TABLE OF CONTENTS

CATERPILLAR .....	1-2 to 1-3
CHEVROLET / GMC .....	1-3 to 1-5
CUMMINS ENGINE .....	1-5 to 1-8
DETROIT DIESEL ENGINES .....	1-8 to 1-10
DIAMOND REO .....	1-10
FORD TRUCK.....	1-10 to 1-14
IHC / NAVISTAR .....	1-14 to 1-15
MACK TRUCK.....	1-15 to 1-16
MERCEDES.....	1-17
PERKINS DIESEL .....	1-17
THERMO KING REFRIGERATION .....	1-17
VOLVO / WHITE TRUCKS .....	1-18

---

**Disclaimer:** The material in this publication has been carefully prepared to provide the latest and most accurate reference information available from the most reliable sources at hand. This book is provided for your convenience as a sales aid. Precision Rebuilders assumes no responsibility for any damages incurred as a result of inaccuracies within this catalog. Any mention of other manufacturer's names, numbers, etc. are for reference purposes only. Referral to those items does in no way imply that the part listed is the product of those manufacturer's.

# CATERPILLAR

Model/Year	Application	OEM #	Casting #	Part #
<b>CATERPILLAR: 1140 thru 3306</b>				
<b>1140 &amp; 1160</b>	3 5/8" Impeller, w/ Press On Reman # OR0644R	9L7660	9L8323	WP1001
<b>3116</b>	Pulley Driven, 4 3/8" Pulley # 7C7890 Pulley Driven, 3 3/4" Pulley	4P3683	4P3681 4P3682	WP1020 WP1021
<b>3176</b>	Gear Driven, w/ Aluminum Housings	7E8554, 9Y4361, 1025844	7E855401, 9Y4361, 103-0745	WP1011
<b>3176</b>	3 <sup>rd</sup> Generation, Cast Iron Body Back Plate Cover # 105-4213	100-6944	105-4214	WP1019
<b>3208</b>	1st Style w/ Press Fit Pulley...	OR0781	9N138, 9L7505	WP1000
	2nd Style w/ Bolt (Less Pulley)...	9N6147	9N3076	WP1000T
	2nd Style w/ 3 Belt, Bolt on Pulley...	2W1225	9N3076	WP1003T
	2nd Style w/ Threaded, Bolt on Pulley for Clutch...	2W1227	9N3076	WP1003TF
<b>3304 &amp; 3306</b>	Small Output Port Style, w/ Serial 23C1566 to 23C1914	2P0662	2P761	WP1008
<b>3304 &amp; 3306</b>	One Large, One Small Output Port Style, Outer Bearing w/ Small O.D. <b>Note: Industrial Applications Only</b>	7N5909	1W4619	WP1008A
<b>3304 &amp; 3306</b>	One Large, One Small Output Port Style, Outer Bearing w/ Small O.D., and Serial 23C1915 & Up	1W3060, 2W8001	1W4619	WP1008B
<b>3304 &amp; 3306</b>	Small Output Ports, w/ Internally Splined Gear	2P0661	6N8413	WP1010
<b>3304 &amp; 3306</b>	Internally Splined Gear	5S6684	5S6664	WP1015
<b>3304 &amp; 3306</b>	One Large, One Small Output Port Style, w/ Internally Splined Gear <b>Note: Industrial Applications Only</b>	1W3058	1W4619	WP1012
<b>3304 &amp; 3306</b>	One Large, One Small Output Port Style, w/ Internally Splined Gear	2W8002	1W4619	WP1013
<b>3304 &amp; 3306</b>	One Large, One Small Output Port Style, w/ Internally Splined Gear & s/n 8Z18853 & up	2W8003	1W6558	WP1014
<b>3406A, 3406B,</b>	6 Cyl. Inline Diesel Engine, w/ 7 7/8", 74 Tooth Flat Gear.	4N7415, 7W7019,		WP1006

# CATERPILLAR

Model/Year	Application	OEM #	Casting #	Part #
<b>CATERPILLAR CONTINUED: 3406 thru 3408</b>				
<b>3406C, 3406D</b>	Note: Two Different Size O'Ring Grooves Cut on Gear Side. Pumps Supplied w/ Proper O'Ring	2W3277, 9N3161, 9N5035, 9Y5646	102-5946 4N1137 9N5034	WP1006
<b>3406E</b>	6 Cyl. Inline Diesel Engine, w/ 7 7/8", 74 Tooth, Dished Gear & angled teeth 6 Cyl. Inline Diesel Engine, w/ 7 7/8", 74 Tooth, Dished Gear & straight teeth	6I3890, 100-9344  161-5719	135-4918 100-7479  161-5719	WP1016  WP1017
<b>3408</b>	Series 28 VI & Up w/4 3/4" 43 Th. Gr.	4N7498	4N1941	WP1009
<b>C12</b>		100-6944	105-4214	WP1019
<b>C15</b>	Single Turbo			WP1016
<b>C15</b>	Twin Turbo			WP1017

## CHEVROLET / GMC TRUCK: Light Duty

<b>15, 25, 35 (72-68)</b>	V-8 w/ 396 or 400 (402) Large Block, Gas Engines	3927564, 14087581	3856284, 3992077	WP1501
<b>C, G, K10-35 1500-3500 (95-88)</b>	V-6 w/ 262 (4.3L), V-8 w/ 305 (5.0L), V-8 w/ 350 (5.7L) Gas Engines Note: 1992 w/ 350 has 0.69" Hub Height (for pump w/ 0.58" Hub Ht. use WP1639)	10077059, 12522031, 12522032	10105828, 10108451, 14102026	WP1627
<b>C, G, K10-35 1500-3500, P3 (96-88)</b>	V-8 w/ 379 (6.2L) (93-92)* & 395 (95-92) (6.5L) Diesel Eng. *(Note: This unit replaces WP1628)	12514574	23500372	WP1629
<b>C, G, K10-35 1500-3500, P3 (93-82)</b>	V-8 w/ 379 (6.2L) Diesel Engine	14061698, 15633465, 23500133	14024206	WP1623
<b>C, G, K, P10-35 1500-3500 (98-96 Late)</b>	V-8 w/ 395 (6.5L) Diesel Engine	12530176, 12534772	12553486, 12557071	WP1635
<b>C, G, K, P10-35 1500-3500 (98-88)</b>	V-8 w/ 454 (7.4L) Gas Engine	10081980, 12521037, 12525123, 12527759	10114105, 10166843, 10240915	WP1626
<b>C, G, K, P, R10-35 1500-3500 (98-96)</b>	V-6 w/ 262 (4.3L), V-8 w/ 305 (5.0L), V-8 w/ 350 (5.7L) Gas Engines	12528917, 12532528	10238199	WP1640
<b>C, G, K, P, R, V 15-35, 1500-3500 (96-77)</b>	V-6 w/ 262 (4.3L), V-8 w/ 350 (5.7L) (96-77) or w/ 305 (5.0L), 400 (6.6L) (86-77 only) Gas Engines	474029, 10048917, 12522033	376444, 10108453	WP1575

# CHEVROLET / GMC

Model/Year	Application	OEM #	Casting #	Part #
<b>CHEVROLET / GMC TRUCK CONTINUED (Light Duty):</b>				
<b>C, G, K, P, R,</b>	L-6 w/ 292 (4.8L) Gas Engine			
<b>V15-35, 1500-3500 (86-78)</b>		474055, 10046305	465802 93412618	WP1630
<b>C, K10-35 1500-3500 (92 Only)</b>	V-8 w/ 350 (5.7L) Gas Engine Note: w/ 0.58" Hub Height, for 0.69" Hub Height see WP1627	12522036	10108457	WP1639
<b>P3, R, V15-35 1500-3500 (97-73)</b>	V-8 w/ 454 (7.4L) Gas Engine	12529308, 14085852	6263707, 12554747	WP1533
<b>CHEVROLET / GMC TRUCK (Medium / Heavy Duty)</b>				
<b>40, 50, 60, H500-890</b>	6 Cyl. w/ 292 Gas Engine (GMC Only)	2340256, 3789536	30511, 3789537	WP442
<b>40, 50, 60 (72-68)</b>	V-8 w/ 307, 327, 350 Gas Engines	3957981, 3998206, 3998207	3868320, 3859326	WP1500
<b>40 thru 80 (75-60)</b>	6 Cyl. w/ 305, C, 351C, E, M, D351, 379, 401M, 432M, D478, 478M Engines. (Same Numbers, both Pumps) w/ 3/4" Hub Pilot... w/ 5/8" Hub Pilot...	2417197 2475788, 8875385, 8885837	3171, 2475787, 518040	WP1430 WP1436
<b>40 thru 85 (80-66)</b>	V-8 w/ 366, 427 Gas Engine w/o Front End PTO (80-66 Models)... w/ Front End PTO only...	3990992, 6258548 3927565	3856286, 3856288 2001584	WP1446 WP1578
<b>40, 50, 60 (74-65)</b>	6 Cyl. w/ 292 Gas Engine (before 1974, 2 <sup>nd</sup> . design)	3876172, 6258119	3861922, 328581	WP1633
<b>45, 50 (78-72)</b>	4 Cyl. Light Duty w/ 153 Gas Engine, 6 Cyl. w/ 194, 230 Gas Engine or 6 Cyl. w/ 250(4.1L) Gas Engine	357261, 3815726, 3876168, 3947042, 6258446	329673, 3788476	WP1625
<b>50, 60 (90-73)</b>	V-8 w/ 350 (5.7L) Gas Engine	6258551, 10048921	30998, 330813, P	WP1534
<b>50, 60 (87-74)</b>	6 Cyl. w/ 292 Gas Engine	357262, 474056	352199, 465802	WP1624
<b>50, 60, 70 B7, P7, Topkick (95-90)</b>	V-8 w/ 366 (6.0L) & 427 (7.0L) Gas Engines (w/Screw On Hub)	10140667, 12520263, 12529192, 12551474	10191700, 14001939	WP1590
<b>60, 65, 70</b>	V-8 w/ 366 (6.0L), 427 (7.0L)			

# CHEVROLET / GMC, CUMMINS

Model/Year	Application	OEM #	Casting #	Part #
<b>CHEVROLET / GMC TRUCK (Medium / Heavy Duty) CONTINUED</b>				
(90-76)	(90-76), & 454 (82-78) Gas Engines	10074182,		
	(w/out Screw On Hub)	14002440	14001939	WP1591
<b>MDS4000, B4000/9000 (67-60)</b>	V-6 & V-12 Gas Engines, (With Air Brakes)	2235969, 2384840, 8885838	2374896	WP575
<b>CUMMINS ENGINE: B SERIES thru L10</b>				
<b>B Series; 4BT3.9, 6BT</b>	4 & 6 Cyl., Pulley w/ Belt Lip, (O.A.H. = 4 5/8") Pulley Cast # 3903657	3003731, 3802004, 4429404	3913432	WP681
<b>B Series; 6BTA5.9</b>	4 & 6 Cyl., Dome Top Pulley w/o Belt Lip (O.A.H. = 5 1/2") Pulley Cast # 3920311, 3920312, 3924141, or 3928396	3913432, R4723690	3920310	WP682
<b>C Series 160, 175, 190</b>	Non-Supercharged Belt Drive, 10° & 15° Tilt Engine	BM34948	105288	WP741
<b>C Series</b>	Michigan Crane w/ 464 Engine and 1 Belt Pulley	n/a	154180	WP741A
<b>CF160, J, JN &amp; JNF-130</b>	Non-Supercharged, Belt Drive, 20° Tilt Engine	BM77548	105781	WP742
<b>C180, CR-160C1</b>	Supercharged, Gear Driven, w/ Backplate # 106337	BM37859	132414	WP635
<b>C8.3 Series</b>	6 Cyl. Engine	3802081, 3905357, 3913430	3802051, 3903357, 3905357	WP683
<b>FFC855 Upgrades</b>	w/ 4 1/2" Imp. & 2 Belt Pulley	n/a	218274	WP638B
	w/ 5 1/4" Imp. & 4 5/8" Poly-Groove Pulley...	3007290	210238, 219040	WP639
	w/ 4 3/4" Imp. & 2 Belt Pulley	AR10637	210238, 219040	WP641
	w/ 4 1/2" Imp. & 2 Belt Pulley	n/a	218274	WP642
	w/ 4 1/2" Imp. & 2 Belt Pulley	AR10787	210238, 219040, 3036877	WP645
<b>H, HR, HRC, HRF, HS, NH-180, 195 NHCT, NHD, NHT, NT, NTC</b>	w/ 5 3/8" Shaft, Right Hand Rotation	BM50446, BM76506	115481, 132423	WP630
	w/ 5 3/8" Shaft, Left Hand Rotation	BM76510	115481, 132423	WP630A
<b>JS, JBS, JNS</b>	Supercharged, Gear Driven Pump	20854-3	101953	WP740

# CUMMINS

Model/Year	Application	OEM #	Casting #	Part #
<b>CUMMINS ENGINE CONTINUED</b>				
<b>K, KT400</b>	K Series, Gear Driven Pump	3022920	206964	WP739
<b>ISM</b>		3803403	3882615	WP671
<b>ISB</b>		R4723690	3920310	WP682
<b>L-10</b>	10 Liter, 4 Bolt Mtg.	3801840, 3803402	3039182, 3031802	WP637
<b>L-10, M-11</b>	10L. & 11L. w/ Celect, 3 Bolt Mtg.	3803403	3882615	WP671
<b>NHCT, NHD</b>	w/ Low Fan, 9 23/32" Shaft Length and Right Hand Rotation	AR4548	130175, 196830	WP633
<b>NT, NTC</b>	w/ Low Fan, 9 7/64" Shaft Length and Right Hand Rotation	AR4547	130175, 196830	WP633A
<b>NHC250</b>	w/ Low Fan, 7 3/16" Non-Threaded Shaft	AR51360	202963	WP633B
<b>NHE, NHS</b>	w/ 8 19/32" Shaft Length and Left Hand Rotation	BM50356	115498, 165135	WP631AA
<b>NHT, NHRS</b>	w/ 8 19/32" Shaft Length and Right Hand Rotation	BM50345	115498, 165135	WP631A
<b>NRT, NRTO</b>	9 3/32" Shaft Length w/ 1 1/2" Thread, and Right Hand Rotation	BM71040	115498, 165135	WP631
<b>NH-250WHC</b>	"Pancake" Style Non-FFC, Tilt Eng. w/ 2 Belt Pulley & 4 1/2" Shaft, Right Hand Rotation	AR4284, BM78372	131732, 154964, 196845	WP632
<b>NH-250WHC</b>	20° Tilt Eng. w/ 2 Belt Pulley & 4 1/2" Shaft, Left Hand Rotation	AR4546, BM79321	131732, 154964, 196845	WP632A
<b>NTC &amp; Formula 290, 350, 400</b>	Big Cam Engines w/ 4 1/2" Impeller & 4 5/8" Poly-Groove Pulley (Additional OE # 3051384, 3051408)	AR45184, 3036876, 3801788	218274	WP638
<b>NTC &amp; Formula 290, 350, 400</b>	Big Cam Engines, w/ WP638 W.P., IP638 Idler and Adjusting Bolt Included	n/a	218274	WP638C
<b>NTC &amp; Formula 300, 350, 400</b>	Big Cam III Engine w/ 4 1/4" Impeller & 4 5/8" Poly-Groove Pulley	3004923, 3022472, 3027174, 3801784	218274, 3045163	use WP638
<b>NTC230</b>	Small Cam FFC, w/ 4 5/8" Poly-Groove Pulley and 4" Impeller	3024671	219040	WP684



# CUMMINS

Model/Year	Application	OEM #	Casting #	Part #
<b>CUMMINS ENGINE CONTINUED</b>				
<b>NTC230</b>	Short Suitcase w/ 2 Belt Pulley	AR45073, 3022471, 3801713	3002520	WP646
<b>NTC230</b>	Short Suitcase w/ Poly-Groove Pulley	3027882	3002520	WP646MG
<b>NT855</b>	Versatile 850, C289 Engine, w/ 4 5/8" Poly-Groove Pulley & 5 1/4" Impeller	3000896	210238	WP640A
<b>N14</b>	14 Liter Engine Modified Suitcase Style w/ extra mounting holes	3803361, 3803605	3069644, 3076523 3084024	WP689 WP689A
<b>Super 250, 270, NT290</b>	Small Cam Series, w/ 2 Belt Pulley & 5 1/4" Impeller	AR45090, 3000886, 3801715	210238, 219040	WP640
<b>Super 250, 270, NT290</b>	Small Cam Series, w/ IP640 Idler and Adjusting Bolt Included	n/a	219040	WP640C
<b>V</b>	V-6, 155 & V-8, 210 Engines...	AR61788, A-34079-A05	555260	WP667
	V-12 Series Engines, Right Hand Rotation...	BM62844	185108	WP687
	V-12 Series Engines, Left Hand Rotation...	BM62845	185109	WP688
<b>V, VT555</b>	V-8 Series Engines (Made In UK)	AR61116	553928	WP668
<b>V, VT555</b>	V-8 Series Engines, w/ 2 Belt Pulley	3014476	3014462	WP669
<b>V, VT903</b>	V-8 Series Engines ( <i>Obsolete, R&amp;R only</i> )	AR5664	196960	WP670
<b>88NT</b>	w/ Narrow Poly-Groove Pulley & Stamped Steel Impeller	3803136, 3803138	3062899	WP644
<b>180, 195, 235, 240</b>	V-6 Engines w/ Low Mount Fan and 4 7/8" Shaft Length	AR00506	150018, 157398	WP634A
<b>200, 265</b>	V-6 Engines w/High Mtg. Fan and 5 1/4" Shaft Length	AR8530, BM78724, BM79557, BM93252	157398	WP634
<b>300, 350, 400, Fleet 300, NTC Formula 300,350, 400, NTC475</b>	Big Cam IV Low RPM Engine w/ 4" Poly-Groove Pulley, 4 1/2" Impeller, and 1/4" Vent Hole	3801708, 3045943	3045163	WP636

# CUMMINS, DETROIT DIESEL

Model/Year	Application	OEM #	Casting #	Part #
<b>CUMMINS ENGINE - IDLERS</b>				
<b>IDLERS</b>	Small Cam Engine, 2 Belt	AR8851	208118	IP640
	Big Cam Engines, Poly-Groove	AR45189	215397	IP638
	L-10 Series Engine, Poly-Groove	3034969	3034316	IP637
	L-10 Second Series, Poly-Groove (Cover # 3060884)	3062602	3060883	IP671
	88NT Engine, Narrow Poly-Groove	3053537, 3062931, 3081234	3062693, 3064201	IP644
	88NT, Narrow, Stamped Steel Pulley	3065000	n/a	IP644A
	88NT Engine, Narrow Poly-Groove Pulley w/ Bracket	3062930	3046809 + 3064201R	IP644B
	N14, Poly-Groove	3066330	3072355	IP689
<b>DETROIT DIESEL ENGINES: 53 SERIES thru I-71 SERIES</b>				
<b>53 Series</b>	2-53, 3-53, 4-53, Right Hand Outlet, w/ One Threaded Port or w/ Two Threaded Ports	5109046 5144686	5119281 5144889	WP1387A WP1387
<b>53 Series</b>	2-53, 3-53, 4-53, Left Hand Outlet, w/ One Threaded Port or w/ Two Threaded Ports	5109551 5144685	5119280 5144688	WP1388A WP1388
<b>60 Series</b>	Gear Driven w/ One Outlet	8929509, 23509067, 23514989	8929511, 23505018	WP1400
<b>60 Series</b>	Second Series, Gear Driven w/ Two outlets all cast# above w/ 1/4" pipe ports this cast# w/ 3/8" pipe port	23505895, 23514990, 23516416	23505894, 23516417 23517027	WP1409
<b>60 Series</b>	Second Series, Gear Driven w/ 2 outlets, High horsepower 470 & up, 3/8" pipe ports & high capacity 6 vane impeller	23517028, 23518215 23522707	23517027	WP1408
<b>6110 Series</b>	6110 Engines	5120882	5182119	WP1403
<b>8.2 Liter</b>	Early Style w/o Heater Bypass	8922302	8820383	WP1399
<b>8.2 Liter</b>	Late Style w/ Heater Bypass (Aftermarket Casting # 40-181)	8927158, 8928672	40-181, 8924657, 8926904	WP1399A

# DETROIT DIESEL

Model/Year	Application	OEM #	Casting #	Part #
<b>DETROIT DIESEL ENGINES CONTINUED</b>				
<b>I-71</b>	Inline 71 Engines, Standard Capacity, and "below", 50,60,65 Series GMC 6-71, Series 450-900 3-71, 4-71, 6-71 Engines; Note: All Right Hand Output.	5149707  5135596, 5159060, 5186576	5186574, 5178318  5135602	WP1257  WP1257
<b>I-71</b>	Inline 71 Engines, Standard Capacity, and "below",  50, 60, 65 Series GMC 6-71, V-6, V-6-71 Engines. Note: All Left Hand Outlet	5149706, 5150439, 5159059, 5186575  5123625, 5126877, 5135595	5178317, 5186573  5135601	WP1257A  WP1257A
<b>I-71</b>	Inline 71 Engines, High Capacity, Right Hand Outlet	5149708, 8920916	5182070, 8920918, 5135611	WP601
<b>I-71</b>	Inline 71 Engines, High Capacity, Left Hand Outlet	5149710, 8920915	5182069, 8920917	WP601A
<b>V-71</b>	V-6 & V-8 Engines: "Standing", w/o Heater Bypass. (i.e. Standard Capacity) (Note: WP1395 casting can be used)	5149328	5106160, 5117921, 5135455	WP1394
<b>V-71</b>	"Standing", w/ Heater Bypass (i.e. High Capacity)	5149326, 23506790	5117921, 5135455	WP1395
<b>V-71</b>	"Running", w/o Heater Bypass (i.e. Standard Capacity) (WP1396A Casting Can Be Used)	5149329	5134621, 5142273	WP1396
<b>V-71</b>	"Running", w/ Heater Bypass (i.e. High Capacity)	5149327	5142273	WP1396A
<b>V-71</b>	"Standing", w/ Reverse Gear (i.e. High Capacity)	5149382	5117921, 5135455	WP1395R
<b>V-71</b>	"Running", w/ Reverse Gear	5149381	5142273	WP1396R
<b>V-71</b>	12V71 "Standing", Standard Capacity	5149323	5117970	WP1378
<b>V-71</b>	12V71 "Standing", High Capacity	5149321	5145089	WP1379
<b>V-71</b>	12V71 "Standing", H.C., 2 Leg	5149330	5130701	WP1404
<b>V-71</b>	16V71, 2 Leg	5149336	5142758	WP1401
<b>V-71</b>	16V71, 3 Leg	5149332	5134355	WP1402
<b>V-92</b>	V-6 & V-8 Engines, "Walking" Style (Note: 3 weep hole styles, do not	8921105, 8922336	5101261, 8921100,	

# DETROIT DIESEL, DIAMOND REO, FORD

Model/Year	Application	OEM #	Casting #	Part #
<b>DETROIT DIESEL ENGINES CONTINUED</b>				
	effect pump performance)		8922325	WP1395A
<b>V-92</b>	V-6 & V-8 Engines, "Running" Style (Note: 3 weep hole styles, do not effect pump performance)	8921104, 8922335	5101162, 8921099, 8922326	WP1397
<b>V-92</b>	V-6 & V-8 Engines, "walking" style w/reverse gear			WP1395AR

<b>DIAMOND REO</b>				
<b>OH-110, 130, OA-255</b>	Vertical Engines	1600743	1003A7, 1295-A7	WP273A
<b>OA-292, 331, OH-145, 170</b>	Tilt Engines	1601537	1393-A7	WP276A
<b>OH186</b>	Vertical Engine	1602437	1407-A7	WP276
<b>OH200</b>	Tilt Engine	1602581	1407-A8	WP278
<b>OV235</b>	n/a	1601926	1334-A7	WP272A

<b>FORD TRUCK: E &amp; F Light Duty</b>				
<b>E,F100/350 (87-69)</b>	V-8 w/ 255 (4.2L), 302 (5.0L) or 350 (5.8L) Gas Engines	C9TZ-8501A, D0OZ-9501C, D5UZ-8501A, D6ZZ-8501B	C9TE-8505C, D0OE-8505D, D7TE-8505AA	WP1502
<b>E150/350 (92)</b>	I-6 w/ 300 (4.9L) Engine Hub Dia. 3", Bolt Pattern 2.5", Long Tube	F2UZ-8501A	F0TE-8505BA	WP1585
<b>E,F150/350 (96-93)</b>	I-6 w/ 300 (4.9L) Engine Hub Dia. 3", Bolt Pattern 2.5", Mtg. Boss Ht. = 1.03"	F3TZ-8501E, F5TZ-8501A, F6TE-8501K	F3UE-8505AA, F4TE-8505AA, F6TE-8505LA	WP1549
<b>E,F150/350</b>	V-8 w/ 302 (5.0L) or 350 (5.8L) Gas Engines	E7TZ-8501A, F0TZ-8501E, F3TZ-8501C	E5ZE-8505AA, E9TE-8505AA, E9TE-8505A4A	WP1567
<b>E,F150/350 (92-87)</b>	I-6 w/ 300 (4.9L) Engine (92) F Series only Hub Dia. 2.25 to 3.25", Bolt Pattern 2.5", w/ Long Bent Tube	E7TZ-8501B, F0TZ-8501F	E3TE-8505DA, E9TE-8505DA, F0TE-8505BA	WP1510
<b>E,F150/350 (86-83)</b>	I-6 w/ 300 (4.9L) Engine (except 84 w/ DWR) Hub Dia. 2.312 to 3/25", Bolt Pattern 2.5", w/ Short Tube	E3TZ8501C, E9PZ-8501A, F0PZ-8501A	30994, D2TE-8505AA, E3TE-8505D	WP1511
<b>E,F150/350 (82-77)</b>	I-6 w/ 300 (4.9L) engine Hub Dia. 2.312", Bolt Pattern 2.75" w/ Very Short Tube	D5TZ-8501B, E4TZ-8501B, E9PZ-8501D	30994, D2TE-8505AA, E3TE-8505DA	WP1548

# DETROIT DIESEL

Model/Year	Application	OEM #	Casting #	Part #
<b>FORD TRUCK CONTINUED</b>				
<b>E250/350 (93-92)</b>	V-8 w/ 460 (7.5L) engine (from 2-3-92)	F2UZ-8501C	F2TE-8505AA	WP1584
<b>E,F250-350, F Super Duty, F53/F59 Stripped</b>	V-8 w/ 446 (7.3L) Direct Injection Turbo Diesel engine (96-95)	F5TZ-8501ARM	1822823C1	WP1581
<b>E,F250-350, F Super Duty, F53/F59 Stripped</b>	V-8 w/ 446 (7.3L) Direct Injection Turbo Diesel engine, 1st design (94 only)	F4TZ-8501ARM	1818182C3, 1818182C4	WP1579
<b>F53/59 Stripped</b>	V-8w/466 (7.3L) Direct injection Turbo diesel 2nd & 3rd design (late '94)	F6TZ8505ARM F6TZ8505BRM	1823611C1 1823611C2	WP1577
<b>E,F250/350, F Super Duty, F53/59 Stripped</b>	V-8 w/ 460 (7.5L) (96-94)	F4TZ-8510B	F4TE-8505BA	WP1583
<b>E,F250/350 (94-83)</b>	V-8 w/ 420 (6.9L) (88-83) & 446 (7.3L) (94-83) Diesel Engines, w/ Threaded Hub.	E4TZ-8501C, E9TZ-8501B	446430C1, 446430C2, 446430C4	WP560F
<b>E, F250-350 ('97) F Super Duty F53/59 Stripped</b>	V-8 w/466 (7.3L) direct injection Turbo Diesel 4th design	F7TZ8501ARM 991919C91	1823423C2	WP1566
<b>E, F250-350 ('98) F Super Duty F53/59 Stripped</b>	V-8 w/466 (7.3L) direct injection Turbo Diesel 4th design	F81Z8505ARM F81Z8505AARM	1831005C2	WP1576
<b>E,F250/350, F Super Duty, F53/59 Stripped (92-75)</b>	V-8 w/ 460 (7.5L) engine (to 2-3-92)	D5TZ-8501G, D8TZ-8501B, E4TZ-8501E, E5TZ-8501C, F1TZ-8501A	D2VE-8505BA, D5VE-8505AA, D8UE-8505AA, F1TE-8505CA	WP1535
<b>F250/350, F Super Duty, F53/59 Stripped</b>	V-8 w/ 460 (7.5L) (93-92, from 2-3-92)	F2TZ-8501A	F2TE-8505AA	WP1566A
<b>FORD TRUCK: MEDIUM / HEAVY DUTY, 400-1100, B SERIES</b>				
<b>400-1100 (69 &amp; Up)</b>	6 Cyl. Cat. 1140-1160 Diesel Eng. w/ 3 Groove Pulley & 3.675" Imp. Dia.	9N1946	1072A734	WP1000
<b>400-1100 (70-65)</b>	6 Cyl. w/ 300 (HD) Engine	C5TZ-8501A, B,C	C5TE-8505A, B,G	WP1460
<b>400-1100 (69-64)</b>	V-8 w/ 330 (HD), 361, 391 Engines, w/ High Fan, (Replaces Pump w/ Press on Pulley # WP1416)	C4TZ-8501G	C8TE-8505E	WP1544
<b>400-1100 (52-48)</b>	V-8 w/ 239 Engine, L.H. Pump	8RT-8502A, 8RT-8502B	30115, 8RT-8506	WP1521
<b>400-1100 (52-48)</b>	V-8 w/ 239 Engine, R.H. Pump	8RT-8501A, 8RT-8501B	30114, 8RT-8505	WP1522

# FORD TRUCK

Model/Year	Application	OEM #	Casting #	Part #
<b>FORD TRUCK CONTINUED</b>				
<b>B600-700, C, F, LN600 (77 only)</b>	V-8 w/ 330 Engine, (From Serial # O65001 to Y45001) w/ 8 Hole Hub (for 4 Hole Hub Version use WP1569)	D7HZ-8501C	D5TE-8505EA	WP1518
<b>B, C, CF, F, FT, L600-800 (95-91)</b>	6 Cyl. w/ 401 (6.6L) & 476 (7.8L) (w/ W.P. Mounted Fan) (Exc.210 H.P.)	F1HZ-8501D	E8HN-8508AB	WP1598
<b>B, C, CF, F, L600-900 (97-90)</b>	6 Cyl. 5.9L FD1060 Cummins Diesel Eng.	F3HZ-8501ARM	3928395	WP682
<b>B, C, CF, F, L600-800 (95-91)</b>	6 Cyl. w/ 401 (6.6L) & 476 (7.8L) Diesel Eng. (w/o W.P. Mounted Fan)	F1HZ-8501C	F0HN-8508AA	WP1599
<b>B, C, CF, F, L700-900 (97-90)</b>	6 Cyl. 8.3L FD1460 Cummins Diesel Eng.	F3HZ-8501BRM	3905357	WP683
<b>B, C, CT, F, L, LN, LNS, LT, LTS600-800 (97-79)</b>	V-8 w/ 370, 429 Engines	D9HZ-8501A, E2HZ-8501B, E5HZ-8501A, F1HZ-8501E F5HZ-8501AA	D9TE-8505CC E2TE-8505AA E4TE-AA F1HE-8505CA F5HE-8505AA	WP1595
<b>B, C, CT, F, L, LN, LNS, LT, LTS400-1100 (75-64)</b>	V-8 w/ 330 (HD), 361, 391 Engines (W.P. or Crankshaft Mounted Fan) (Replaces Pump w/ Press on Pulley) (Use Only 4 Blade Steel or 5 Blade Aluminum Fan)	C4TZ-8501H, D0TZ-8501B, D4TZ-8501M, D4TZ-8501G	C8TE-8505F, D3TE-8505CB	WP1527
<b>B, C, CT, F, LN500-800 (78-75)</b>	V-8 w/ 359, 361, 389, 391 Engines, w/ Low Fan, from Serial # V80,001 & Serial # Y45001 to BC5001	D5TZ-8501D, D7HZ-8501D,F	D5TE-8505EA	WP1573
<b>B, C, CT, F, LN600-800 (75-74)</b>	V-8 w/ 359, 361, 389, 391 Engines, before Serial # V80001	D4TZ-8501K	D3TE-8505CB	WP1571
<b>B, C, CT, F, N, T600-800 (69-64)</b>	V-8 w/ 330 (HD), 361, 391 Engines, (w/ W. P. or Crankshaft Mounted Fan), (Can Be Used w/ 5 Blade Steel Fan), 2 Belt Press on Pulley	C4TZ-8501A, C4TZ-8501C, C4TZ-8501F, C4TZ-8501H	C4TE-8505D, C8TE-8505F	WP1415
<b>B, C, F, LN500-700 (78-75)</b>	V-8 w/ 330 (MD) Eng. from Serial # W00001; 330 Eng. to Serial # O65001; 330 Eng. from Serial # Y45001 to BC5001 w/ 4 Hole Hub (for 8 Hole Hub version use WP1518)	D5TZ-8501E, D7HZ-8501E	D5TE-8505EA	WP1569
<b>B, C, F, LN, P500-600 (78-71)</b>	6 Cyl. w/ 300 Engine	D1TZ-8501A, D2TZ-8501A, D5TZ-8501C	C8TE-8505G, D2TE-8505AA	WP1509
<b>B, F, L 600-800 (91-87)</b>	6 Cyl. w/ 401 (6.6L), 476 (7.8L) Diesel Engines, (before 10-1-90) (Note: WP1593 is NLA, use this #)	E7HZ-8501B, E8HZ-8501B	E6HN-8508AA, E7HN-8508AA	WP1594

# FORD

Model/Year	Application	OEM #	Casting #	Part #
------------	-------------	-------	-----------	--------

## FORD TRUCK CONTINUED

<b>B, C, F, N500-700 M450-500 (74-65)</b>	V-8 w/ 330 (MD) & 360, 390 Engines	C5AZ-8501C, G,M,R,U,V, D0AZ-8501A, D0AZ-8501D, D4TZ-8501H	C5AE-8505A, C6AE-8505B, C8AE-8505D,H, C9AE-8505A, D4TE-8505A2A	WP1515
<b>B, C, F, N500-700</b>	V-8 w/ 330 (MD) Engine (64 only)	C4AZ-8501A	C4SE-8505	WP1519
<b>B, C, F, N, P, T400-700 (64-56)</b>	V-8 w/ 272 & 292 Engines	B6C-8501A,B	ECW-8505A	WP1520
<b>B, F, N, P400-600 (64-54)</b>	6 Cyl. w/ 223 Engine (w/ Fan Hub 4 23/64" from Fan Side of Hub to Mounting Surface)	B6C-8501C	EBP-8505A, C3TE-8505B	WP1513
<b>BRAZILIAN, CF</b>	6 Cyl. w/ 7.8L Diesel Engine	n/a	E5HN-8508AB	WP1597
<b>C, CT900 (74-73)</b>	V-8 w/ 401, 477, 534 and 2-Belt Pulley	D2TZ-8501B	C8TE-8505B	WP1329A

## FORD TRUCK: MEDIUM / HEAVY DUTY, C thru L SERIES

<b>C, CT, L, LN, LNS, LT, LTS 600-800 (78-75)</b>	V-8 w/ 330, 359, 361, 389, 391 Eng., w/ High Fan and Serial # from V80001 to BC5001 and BC5001 & up	D5TZ-8501F, D7HZ-8501F, D8HZ-8501A	D5TE-8505DA, D8TE-8505AA	WP1574
<b>C, CT, L, LN, LNS, LT, LTS800-900</b>	V-8 w/ 475, 477, 534 Engines (81-78) w/4" hub bolt pattern	D8HZ-8501B	D5HE-8508AA	WP1580
<b>CF</b>	6 Cyl. w/ 6.6L Diesel Engine	n/a	E5HN-8508AA	WP1589
<b>CF600-800 (86 only)</b>	6 Cyl. w/ 401 (6.6L) Diesel Engine	E6HZ-8501A	21600-1	WP1592
<b>F, T700-800 (69-64)</b>	V-8 w/ 330 (HD), 361, 391 Engines, (High Fan Model), 2 Belt, Press on Pulley	C4TZ-8501B, C4TZ-8501D, C4TZ-8501G	C4TE-8505C, C7TE-8505B, C8TE-8505E	WP1416
<b>F800-880 (81-76)</b>	V-8 w/ 477, 534 Engine w/3 1/2" hub bolt pattern	D6HZ-8501A	D5HE-8508AA	WP1596
<b>F, N, NT850-1000; T750-950(69-65) L, LN, LNT, LT, LTS880-900(73-70)</b>	V-8 w/ 401, 475, 477, 534 Engines, Some Models w/o Variable Speed Fan. (w/ Hub) w/ Single Belt Pulley	B8Q-8501A, B8TZ-8501A, B8TZ-8501C B8TZ-8501C	C1TE-8503A, EDL-8508A, C8TE-8508B (see above)	WP1328 WP1329
<b>L, LN, LNT, LT, LTS600-800 (72-70)</b>	V-8 w/ 361, 391 Engines (w/ High Fan), from Serial # J50001	D1TZ-8501C	D0TE-8505C	WP1529
<b>L, LN, LNT, LT, LTS800 (75-74)</b>	V-8 w/ 361, 389, 391 Engines, from Serial # T40000 to V80001, and Serial # T40001 to U80001	D4TZ-8501F, D4TZ-8501L	D3TE-8505BB	WP1572

# FORD TRUCK, INTERNATIONAL

Model/Year	Application	OEM #	Casting #	Part #
<b>FORD TRUCKS</b>				
<b>LNT, LT, LTS 600-800 (72-70)</b>	V-8 330 (H.D.) (w/ High Fan), from Serial # J50001	D1TZ-8501B	D0TE-8505C	WP1528
<b>M450-500 (76-74)</b>	V-8 w/ 460 Engine	D4TZ-8501D	D4TE-8505BB	WP1497
<b>P400-500 (77-73)</b>	6 Cyl. w/ 240, 300 Engines	D2AZ-8501A, D5TZ-8501A	D2AE-8505A	WP1435
<b>P500 (77)</b>	6 Cyl. w/ 300 Engine, from Serial # O80001, Calif. only	D5TZ-8501B	D2TE-8505AA	WP1548

<b>IHC / NAVISTAR</b>				
<b>152, 196, V266, V304, V345, V392</b>	Hub Threaded for Fan Clutch... Hub w/ 4 Threaded Holes... Hub w/ 8 Threaded Holes...	861236R92 270918C92 463365C91	151203R1 151203R1 151203R1	WP573S WP573 WP1552
<b>196, V266, V304, V345, V392</b>	4 & 8 Cyl. Gas Engines w/ Fan Clutch	357621C92	151203R1M	WP550
<b>BO220, 240, 264, BG220</b>	Gas Engine w/ 1 Bypass Hole... w/ 2 Bypass Holes...	78903R91 170027R91 260540C92	69495R11, 169204R1	WP1244 WP1244A
<b>Cargostar</b>	Cab Over w/ DT466 Engine	680899C91 680899C92 680899C93	677137C1	WP563
<b>Cargostar, Fleetstar, S Series</b>	Models C01610A thru C0F-1950B; Models 2010A thru F2070A; and Models 1624 thru F2155 & 2275 thru F2674 w/ V537 Gas Engine	448087C92	281761C2	WP1478
<b>Cargostar, Fleetstar, Loadstar, Paystar, S Series,</b>	w/ D170, 190, VS401, DV462B, 478, 549, FTVS549, & 550B Eng.; w/D170, 190, VS401, 478, 549, FTVS549, & DV550 Engines; w/ DV462B & 550B Engines; w/ D190, VS549, & DV550B Eng.; Models 1624 thru 2125 & 2155 w/ D150, D170, D190 Engines w/o Direct Drive Fan;			
<b>VARIOUS</b>	VS401, VS478, VS549, FVTS549, DV462, DV462B, DV550, DV550B Diesel Engines. (w/o Pulley)	297359C93	281761C2	WP1478NP
<b>Cargostar, Loadstar, S Series</b>	w/ 420 (6.9L) Diesel or 404, 446 Gas Engine; (w/ Small Non-threaded Hub)	1805951C91, 1805952C91, 1809374C91	446430C1, 446430C2, 446430C4	WP560
<b>Cargostar S Series,</b>	9.0 Liter Diesel Engine	1700594C91	489173C1	WP1479



# INTERNATIONAL

Model/Year	Application	OEM #	Casting #	Part #
<b>MERCEDES, THERMO KING</b>				

<b>RD372, 406</b>	All Early Series	87512R92	145305, 140472H, 98445H	WP132
<b>RD450, 501</b>	All Late Series	218150R91	214408R1	WP574
<b>S Series</b>	Conventional Cab w/ DT466 Eng.	685155C91, 685155C92, 685155C95	677856C1, 677856C2	WP563A
<b>VARIOUS</b>	w/ D301, B, BC160 to 180 Series Diesel Engines	303395R92, 318119R92	303394R1, 318118R4	WP571
<b>VARIOUS</b>	6 Cyl. DT360 Diesel Engine (w/ left hand thread, similar to WP563)	1815538C91	677856C3	WP565
<b>VARIOUS</b>	6 Cyl. DT360 / 466 New Generation Diesel Engines	1817687C92	1821935C91 1821935C3	WP568
<b>VARIOUS</b>	6 Cyl. DT444E Diesel Engine (from S/N 58558 & up)	1823669C92	1822851C1 1822851C2	WP559

<b>MACK TRUCKS: A-20 thru ENDT673</b>				
---------------------------------------	--	--	--	--

<b>A-20, EN331</b>	6 Cyl. Gas Engines	316GC235	771GB444	WP790
<b>A40, 42, EN377</b>	6 Cyl. Gas Engines	316GC236	360GB420	WP791
<b>B421</b>	Model Only w/o Oil Cooler	316GC174B	771GB454	WP790A
<b>B61, 65, H61, 63, 75</b>	6 Cyl. Diesel Engines (w/o Hub) 6 Cyl. Diesel Eng. w/o Hub & w/ Stamped Steel Impeller	316GC184	360GB325	WP794 WP794S
<b>EN354, 354A</b>	6 Cyl. Gas Engines	316GC22C	360GB47	WP789
<b>EN401</b>	6 Cyl. Gas Engines	316GC150	360GB121	WP792
<b>EN402</b>	N-42 Models	316GC245	360GB427	WP797
<b>END475</b>	6 Cyl. Scandia Diesel w/ 2 Outlets... 6 Cyl. Scandia Diesel w/ 1 Outlet...	818X13618 n/a	131680 n/a	WP799 WP800
<b>EN, END, 510, 510A</b>	6 Cyl. Gas Engines ... 6 Cyl. Diesel Engines...	316GC133 316GC149	360GB468 360GB31	WP673 WP675
<b>EN540</b>	6 Cyl. Gas Engines w/ 1 Outlet... 6 Cyl. Gas Engines w/ 2 Outlets...	316GC239 316GC259A	360GB326 360GB438	WP793 WP798
<b>END673</b>	6 Cyl. Diesel Engines w/ Hub	316GC184N	360GB325	WP794WH

# MACK TRUCKS

Model/Year	Application	OEM #	Casting #	Part #
<b>MACK TRUCKS</b>				
<b>ENDT673</b> <b>(Thermodyne)</b>	Except N Models w/ Air Outlet	316GC184H	360GB334	WP794A
<b>ENDT675</b> <b>(Maxidyne)</b>	6 Cyl. Diesel w/o Hub & Pulley, w/ Cast Iron Impeller ... w/ Stamped Steel Impeller...	316GC1184B	360GB343, 360GB443	WP794B
	w/ 1st Style Hub & A/C Pulley...	316GC1184H	360GB443	WP794BS WP1184
	w/ 2nd Style Hub & A/C Pulley...	316GC1211A	360GB443	WP1211
<b>ENDT675ESI</b> <b>(Econodyne)</b>	EMS6 w/ Charged Air System, Short Shaft w/o Pulley...	316GC1210	360GB443	WP1210NP
	w/ 3 Belt, 6 5/8" Cast Pulley...	316GC1210A	360GB443	WP1210
	w/ 3 Belt 5 1/2" Cast Pulley...	316GC528A	360GB443	WP528
	w/ 4 Belt 6 5/8" Cast Pulley...	316GC1184BP2	360GB443	WP1184B
<b>E6</b>	Mack E6 series w/metric housing & stamped impeller; w/ 3 groove pulley	316GC549MX	360GB443A	WP1229
<b>E7</b>	6 Cyl. Diesel w/ Stamped Imp. Mack E7 series w/metric housing & stamped impeller; w/ 7 1/4" pulley	316GC1219	360GB443	WP1219
	Mack E7 series w/metric housing & stamped impeller; w/ 5 1/2" pulley	316GC548M2X	360GB251AM	WP1227
	Mack E7 series w/stamped impeller & metric housing; w/o pulley	316GC548MX	316GB251AM	WP1228
	Mack E7 series w/stamped impeller, metric housing & 3 belt pulley	316GC284	360GB251AM	WP1230
	Mack E7 series w/stamped impeller & 3 groove 6 5/8" pulley (pulley# 302GC499 or 302GC459)	316GC4107MX	360GB251AM	WP1232
	Mack E7 series w/stamped impeller & 3 groove pulley (pulley# 302GC462M)	316GC548M4X	360GB251AM	WP1233
	Mack E7 series w/metric housing & stamped impeller; w/ 5 1/2" poly groove pulley	316GC4108MX	360GB251AM	WP1234
	Mack E7 series w/stamped impeller & multi-groove belt pulley (pulley# 302GC476M)	316GC551M2X	360GB251AM	WP1236
		316GC551MX	360GB251AM	WP1237
<b>EN707A, B, C,</b> <b>ENDT673,</b> <b>ENDT711</b>	6 Cyl. Gas Engines; 6 Cyl. Diesel Engine, N Models & 6 Cyl. Diesel Engines	316GC1179	360GB241	WP787
<b>END864</b>	V-8 Diesel w/ Small Gear Drive	316GC1151	360GB238	WP795
<b>ENDT864</b>	V-8 Diesel w/ Large Gear Drive	316GC284A	770GB418A	WP284A
<b>MS200</b>	Midliner Straight Truck (Also OEM # 41035000338059X)	338059	500020160, 50020168	WP810
<b>MS300</b>	Midliner Truck, And Tractor w/ Intercooler (w/ Cast # 56000280263BM)	663009	(see left)	WP811
		670157	(see left)	WP812

# MERCEDES, PERKINS, THERMO KING

Model/Year	Application	OEM #	Casting #	Part #
<b>MERCEDES, THERMO KING</b>				
<b>1013, 1113, 1116, 1316</b>	OM 352 Engine	3522009401	35220001, 3522010201, 3522011901, 3527002301	WP1601
<b>1418</b>	OM 355 Engine	3552000101	3522003801	WP1602
<b>T/K</b>	OM 636 4 Cyl. (Thermo-King Appl.)	1812001201	n/a	WP1605

## PERKINS DIESEL: 3A-152 SERIES thru S-288 SERIES

<b>3A-152</b>	3 Cyl. w/ 2 1/2" diameter Hub and 1 Belt Pulley	41312154	37711330,B, 37711331	WP1464A
<b>4-108</b>	4 Cyl. Diesel Engine, w/ 1 Belt Pulley and Hub	U5MW0040	37712330	WP1466
<b>4-212, 4-236, 4-248</b>	4 Cyl. Agricultural, Industrial, & Marine Diesel Engines, w/ Hub... w/ 1 Belt Pulley-Hub...	41312248 n/a	37711690 37711690	WP1461 WP1461A
<b>4-212, 4-236, 4-248</b>	4 Cyl. Agricultural, Industrial, & Marine Diesel Engines, w/ out Pulley	41312506	37711630	WP1462
<b>4A-203, 4AD-203</b>	4 Cyl. Diesel Engine, w/ 1 Belt Pulley-Hub	41312167, 41312574	0080283, 37711260	WP293A
<b>4A-300</b>	4 Cyl. Diesel Engines, w/ 1 Belt, Bolt On, Pulley	n/a	37711390	WP1465
<b>6-288, 305</b>	6 Cyl. Engines, w/ Low Position Pump	41312518	n/a	WP299
<b>6-354, 6-354T</b>	6 Cyl. Engines, w/ Low Position Pump	41313018	37711320	WP624
<b>AD3-153</b>	3 Cyl. w/ 3 1/8" diameter Hub and 1 Belt Pulley	41312159, 41312487	37711330,B, 37711331	WP1464
<b>C201PT</b>	4 Cyl. Isuzu 2207cc. Engine, (Note: Units w/ Bearing Lock Bolt Have No Core Value)	11-4576	BTK, PH374	WP1199

## THERMO KING REFRIGERATION

<b>C220</b>	4 Cyl. Isuzu 2.2 Liter Engine	11-5858	M1,M2,M3	WP1200
<b>C220</b>	4 Cyl. Isuzu 2.2 Liter Engine w/1 1/8" output, w/o threaded auxillary port	11-5858		WP1201
<b>OM636</b>	4 Cyl. Mercedes Diesel, Old Style	11-4642	1362010110, 6362010110,	
	4 Cyl. Mercedes Diesel, New Style	1812001201	n/a	WP1605

# VOVLO WHITE

Model/Year	Application	OEM #	Casting #	Part #
<b>VOLVO / WHITE TRUCKS</b>				
<b>F611, 613, 614, 614T</b>	Volvo TD60 Engines	465542.9, 465475.2	n/a	WP1610
<b>F716, 716T F720, 724</b>	Volvo TD70 Engines	466833.1, 466756	n/a	WP1611

**For White trucks built after 1970 see appropriate engine manufacturer.  
For White truck built before 1970 see Diamond Reo for unit identification.**

# SECTION 2

## PICTURE GUIDE

### TABLE OF CONTENTS

CATERPILLAR.....	2-2 to 2-6
CUMMINS IDLERS .....	2-7
CUMMINS .....	2-8 to 2-13
DETROIT DIESEL.....	2-14 to 2-16
FORD TRUCK.....	2-17 to 2-18
IHC / NAVISTAR.....	2-19 to 2-20
MACK.....	2-21 to 2-23
THERMO KING .....	2-23

## Heavy Duty Diesel Engine Water Pumps Visual Identification Guide

### Caterpillar 1104 & 1106 Engine

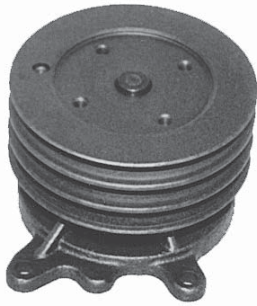

**WP1001**  
Core Class 501

1104 & 1106 engine; Press on pulley, 3-5/8"  
impeller, smaller footprint than WP1003T

Part#	OEM#	Casting#	Description	Gasket Kit
WP1001	OR0781	9N138	Press on Pulley	GK1001

### Caterpillar 3116 / 3126 Engine



**WP1020, WP1021**  
Core Class 509



**WP1022**  
Core Class 509

Part#	OEM#	Casting#	Description	Gasket Kit
WP1020	OR3007, 4P3683, OR1015, 4W0253*	4P3681, 101-7701 187-8957-10	Pulley driven w/ Impeller cover, 4 3/8" pulley #7C7890	GK1020
WP1021	120-8402, OR1013 4P3682	4P3681 107-7701**	Pulley driven w/ Impeller cover, 3 3/4" pulley	GK1020
WP1021		128-5121	Pulley driven w/ Impeller cover, 3 3/4" pulley	TBA

## Heavy Duty Diesel Engine Water Pumps Visual Identification Guide

### Caterpillar 3176B Engine, C-10/C-12



**WP1011**  
Core Class 506

**Note:** Not interchangeable w/ WP1019



**WP1019**  
Core Class 506

**Note:** Not interchangeable w/ WP1011

Part#	OEM#	Casting#	Description	Gasket Kit
WP1011	1025844, 7E8554, OR3709, OR8767	9Y4363 103-0745	Early design, rear cover# 9Y4362, late design, rear dome cover# 7E8545 41 tooth, 4-5/8" gear, aluminum body w/ aluminum impeller cover	GK1011
WP1019	1006944, OR0705, OR3709, OR8767, 153-8053	105-4214 105-4213 (rear cover)	41 tooth, 4-5/8" Gear, Cast iron body Aluminum impeller cover. Gear# 9Y3513	GK1019

### Caterpillar C-15, C18 Engine



**WP1018**  
Core Class 507



Part#	OEM#	Casting#	Description	Gasket Kit
WP1018	10R2776, 10R3326	244-3237	Straight tooth gear, 8" opening	

## Heavy Duty Diesel Engine Water Pumps Visual Identification Guide

### Caterpillar 3208 Engine



**WP1000T**  
Core Class 501

3208 engine; w/out pulley as illustrated (uses bolt on style pulleys, see below), w/ 4-1/4" impeller

Part#	OEM#	Casting#	Description	Gasket Kit
WP1000T	9N6147	9N3076	Without Pulley	GK1001



**WP1003T**  
Core Class 501



**WP1003TF**  
Core Class 501

Part#	OEM#	Casting#	Description	Gasket Kit
WP1003T	2W1225	9N3076	3208 engine. bolt on pulley, w/4 1/4" impeller	GK1003
WP1003TF	2W1227	9N3076	3208 engine. bolt on threaded pulley for fan clutch, w/4 1/4" impeller	GK1003



Note:  
Spline Drive



**WP1008, WP1010**  
Core Class 504  
WP1010 shown

Part#	OEM#	Casting#	Description	Gasket Kit
WP1008	2P662	2P671	W/o spline, large 3 1/8" OD bearing, bolt on gear# 2P3293 (stamped) or 1P9982 (cast)	n/a
WP1010	2P0661	6N8413	Spline drive, large 3 1/8" OD bearing, bolt on gear# 7N5186 (stamped) or 1P9982 (cast) w/angled teeth	n/a



# Heavy Duty Diesel Engine Water Pumps Visual Identification Guide

## Caterpillar 3306 Engine

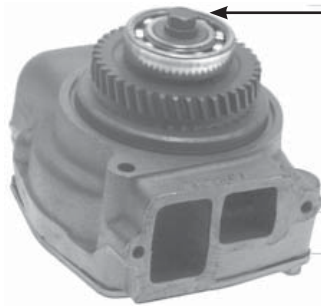

Note:  
Bolt Holding Gear in  
Place, no spline drive

**WP1008A, WP1008B**  
Core Class 504  
WP1008B shown

Part#	OEM#	Casting#	Description	Gasket Kit
WP1008A	7N5909	1W4619	Pinned shaft & gear for industrial applications only. Small 2 3/4" bearing, Gear# 2W7678 (7N5193) or 7N5178 (stamped)	n/a
WP1008B	2W8001	1W4619	Large & small output ports, small 2 3/4" bearing, gear# 7W0450	n/a

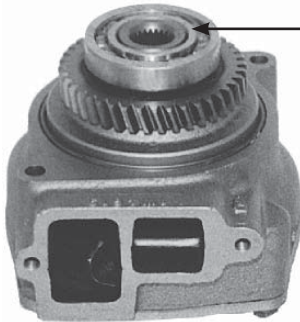

Note:  
Spline Drive

**WP1012, WP1013**  
Core Class 504

Part#	OEM#	Casting#	Description	Gasket Kit
WP1012	OR9785, OR1002, 1W3058	1W4619	Pinned shaft & gear for industrial applications only. 3 1/8" bearing, gear# 1P9982 (cast#), 7N5186 (OEM#)	n/a
WP1013	2W8002	1W4619	Large & small output ports, large 3 1/8" bearing, gear# 2W7678 (OEM#) or 7N5178 (cast#)	n/a

## Heavy Duty Diesel Engine Water Pumps Visual Identification Guide

### Caterpillar 3406A, B Engine

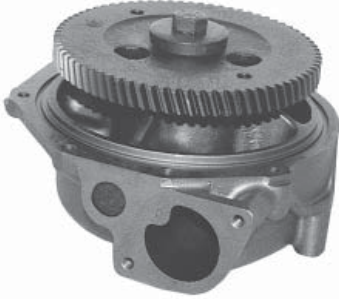

**WP1006**  
Core Class 502

**Note:** Not interchangeable w/ WP1016

Part#	OEM#	Casting#	Description	Gasket Kit
WP1006	7W7019, OR8217	9N5034	74 tooth gear, 7-7/8" diameter	GK1006

### Caterpillar 3406E Engine, C-15/C-16



**Note:**  
Dished Gear  
w/angled  
teeth



**WP1016**  
Core Class 507  
**Note:** Not interchangeable  
with WP1006

Part#	OEM#	Casting#	Description	Gasket Kit
WP1016	6I3890,OR4120	100-7479	74 tooth, 7-7/8" dia. dished gear w/ angled teeth.	GK1006



**Note:**  
Dished Gear  
w/straight teeth

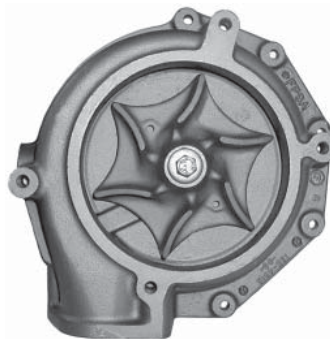







**WP1017**  
Core Class 507

**Note:** Not interchangeable w/ WP1006

Part#	OEM#	Casting#	Description	Gasket Kit
WP1017	1OR0484, 1OR6869 161-5719 (Cat new#)	161-5718 153-9023 (gear#)	74 tooth, 7-7/8" dia. dished gear w/ straight teeth.	GK1006

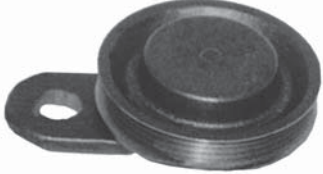
## Heavy Duty Diesel Engine Water Pumps Visual Identification Guide

<i>Cummins L-10 Idler</i>				<i>Cummins Big Cam Idler</i>			
<b>IP637</b> Core Class 527				<b>IP638</b> Core Class 516			
8 grooves, w/ bolt on bearing cover				Big Cam engine; 6 grooves			
Part#	OEM#	Casting#		Part#	OEM#	Casting#	
IP637	3034969	3062602		IP638	AR45189	3064919	
<i>Cummins Small Cam Idler</i>				<i>Cummins L-10 Idler</i>			
<b>IP640</b> Core Class 515				<b>IP671</b> Core Class 527			
Small Cam engine; 2 belt pulley				8 grooves w/ press on bearing cover			
Part#	OEM#	Casting#		Part#	OEM#	Casting#	
IP640	AR8851	3064920		IP671	3062602	3060884	
<i>Cummins 88NT Idler</i>				<i>Cummins 88NT Idler</i>			
<b>IP644</b> Core Class 520				<b>IP644A</b> Core Class n/a New only			
Note: 4 groove pulley				Note: Flat stamped steel pulley			
Part#	OEM#	Casting#		Part#	OEM#	Casting#	
IP644	3062931	3064201R		IP644A	3065000	N/A	
<i>Cummins N14 Idler</i>							
<b>IP689</b> Core Class 516							
Note: N14 engine, 6 grooves, w/ press-on bearing cover							
Part#	OEM#	Casting#					
IP689	3066330	N/A					

## Heavy Duty Diesel Engine Water Pumps Visual Identification Guide

### *Cummins B Series Engine*



**4BT3.9, 6BT  
WP681  
Core Class 528**



**6BTA5.9, 6BT  
WP682  
Core Class 528**

Part#	OEM#	Casting#	Description	Gasket Kit
WP681	3003731, 3802004, 4429404	115481, 132423	Pulley w/ belt lip	GK681
WP682	3913432, R4723690	3920310	Pulley w/o belt lip	GK682

### *Cummins C Series Engine*



**C8.3  
WP683  
Core Class 529**

**C8.3  
WP685  
Core Class 529**



Part#	OEM#	Casting#	Description	Gasket Kit
WP683	3802081, 3905357, 3913430	3802051, 3903357, 3905357	Pulley w/ belt lip	GK683
WP685		2369-10, 2370-10, 1926-10	Dome Pulley	GK683

### *Cummins FFC Series Engine*



**FFC855  
WP638B  
Core Class 510**

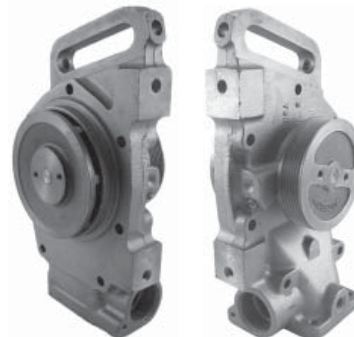

**FFC855 Upgrade  
WP639  
Core Class 510**

Part#	OEM#	Casting#	Description	Gasket Kit
WP638B	N/A	218274	4 1/2" impeller, 2 belt pulley	GK638
WP639	3007290	210238, 219040	5 1/4" impeller & 4 5/8" poly-groove pulley	GK638

# Heavy Duty Diesel Engine Water Pumps Visual Identification Guide

## Cummins FFC Series Engine



**FFC855 Upgrade  
WP642  
Core Class 510**



**FFC855 Upgrades  
WP641 & WP645  
Core Class 510**



Part#	OEM#	Casting#	Description	Gasket Kit
WP641	AR10637	219238, 219040	4 3/4" impeller & 2 belt pulley	GK638
WP642	N/A	218274	4 1/2" impeller & 2 belt pulley	GK638
WP645	AR10787	210238, 219040, 3036877	4 1/2" impeller & 2 belt pulley	GK638

## Cummins H & N Series Engine

Note fin: →  
Right hand rotation

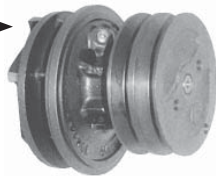

**H, HR, HRC, HRF, HS  
WP630  
Core Class 524**



← Note fin:  
Left hand rotation

**NH-180, NH-195, NHCT, NHD, NHT, NT, NTC  
WP630A  
Core Class 524**

Part#	OEM#	Casting#	Description	Gasket Kit
WP630	BM50446 BM76506	115481, 132423	5-3/8" shaft, 2 belt pulley provided. Right hand rotation	GK630
WP630A	BM76510	115481, 132423	5-3/8" shaft, 2 belt pulley provide. Left hand rotation.	GK630

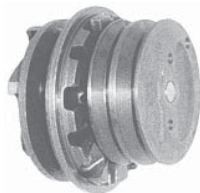

**NH-250WHC  
WP632, WP632A  
Core Class 511**

Part#	OEM#	Casting#	Description	Gasket Kit
WP632	AR4248, BM78372	131732, 154964, 196845	Pancake style non-FFC tilt eng. w/2 belt pulley, 4 1/2" shaft, RH rotation	GK632
WP632A	AR4546, BM79321	131732, 154964, 196845	20° Tilt Engine.. w/2 belt pulley, 4 1/2" shaft, left hand rotation	GK632

## Heavy Duty Diesel Engine Water Pumps Visual Identification Guide

### *Cummins H & N Series Engine*

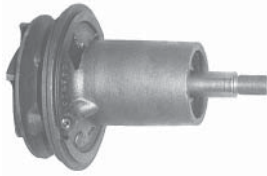

**NHCT, NHD  
WP633  
Core Class 512**

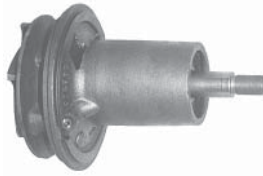

**NT, NTC  
WP633A  
Core Class 512**

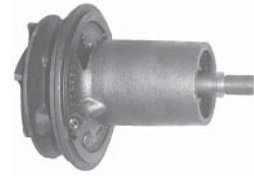

**NHE, NHS  
WP633B  
Core Class 512**

Part#	OEM#	Casting#	Description	Gasket Kit
WP633	AR4548	130175, 196830	w/ low fan, 9 23/32" shaft, Right hand rotation	GK632
WP633A	AR4547	130175, 196830	w/ 8 19/32" shaft, Right hand rotation	GK632
WP633B	AR51360	202963	w/ low fan, 7 3/16" non threaded shaft, Right hand rotation	GK632

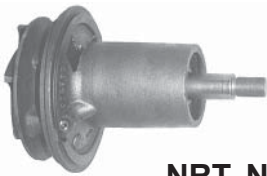

**NRT, NRTO  
WP631  
Core Class 525**



**NHT, NHRS  
WP631A  
Core Class 525**

Note fin: →  
Left hand rotation



**NHE, NHS  
WP631AA  
Core Class 525**

Part#	OEM#	Casting#	Description	Gasket Kit
WP631	BM71040	115498, 165135	w/ 9 3/32" shaft, w/1 1/2" thread, Right hand rotation	GK630
WP631A	BM50345	115498, 165135	w/ 8 19/32" shaft, Right hand rotation	GK630
WP631AA	BM50356	115498, 165135	w/ 8 19/32" shaft, Left hand rotation	GK630

### *Cummins L & M Series Engine*



**L-10  
WP637  
Core Class 517**



**L-10, M11  
WP671  
Core Class 517**

Part#	OEM#	Casting#	Description	Gasket Kit
WP637	3801840, 3803402	3039182, 3031802	L10 "old style" engine; 4 bolt mount, w/ gear cover	GK637
WP671	3803403	388615	L10 & M11 "new style" engine; 3 bolt mount w/ gear exposed	GK671

# Heavy Duty Diesel Engine Water Pumps

## Visual Identification Guide

### Cummins N Series Engine



**NTC & Formula**  
**290, 350, 400**  
**WP638**  
Core Class 510



**NTC & Formula**  
**290, 350, 400**  
**WP638C**  
Core Class 590



**NTC230**  
**WP684**  
Core Class 510

Part#	OEM#	Casting#	Description	Gasket Kit
WP638	AR45184, 3036876, 3801788	218274	Big Cam eng. w/ 4 1/2" Impeller, 4 5/8" poly groove pulley	GK638
WP638C	N/A	218274	Big Cam eng. w/WP638 pump & IP638 idler & adj. bolt included	GK638
WP638A	3004923, 3022472, 3027174, 3801784	218274, 3045163	No longer available. Use WP638	GK638
WP684	3024671	219040	Small Cam FFC w/ 4" Impeller, 4 5/8" poly groove pulley	GK638

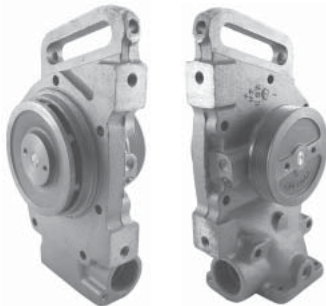

**NT855**  
**WP640A**  
Core Class 510

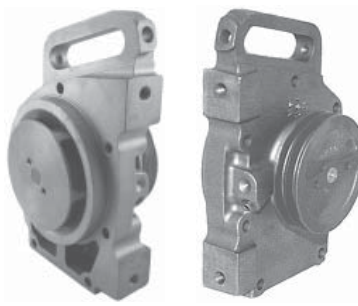

**NTC230**  
**WP646**  
Core Class 514

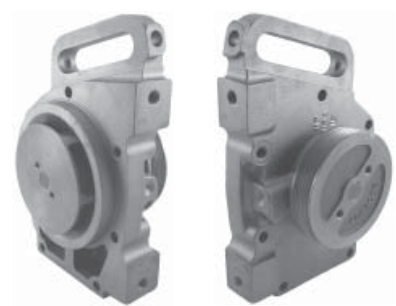

**NTC230**  
**WP646MG**  
Core Class 514

Part#	OEM#	Casting#	Description	Gasket Kit
WP640A	3000896	210238	Versatile 850, w/ poly groove pulley	GK638
WP646	AR45073, 3022471, 3801713	3002520	Short suitcase w/2 belt pulley	GK646
WP646MG	3027882	3002520	Short suitcase w/poly groove pulley	GK646

## Heavy Duty Diesel Engine Water Pumps Visual Identification Guide

### Cummins N Series Engine



**N14  
WP689  
Core Class 591**



Part#	OEM#	Casting#	Description	Gasket Kit
WP689	38033661, 3803605	3069644, 3076523	14 Liter eng., Modified suitcase style, multi groove pulley, 6 bolt mounting.	GK689
WP689A		3084024	N14 w/extra mounting holes	Gk689

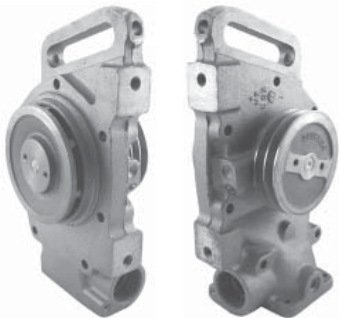

**Super 250, 270, NT290  
WP640  
Core Class 510**

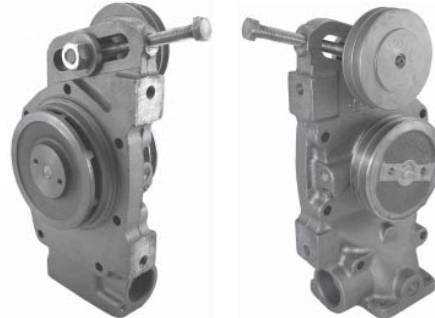

**Super 250, 270, NT290  
WP640C  
Core Class 590**

Part#	OEM#	Casting#	Description	Gasket Kit
WP640	AR45090, 300886, 3801715	210238, 219040	Small Cam series w/ 2 belt pulley, 5 1/4" impeller	GK638
WP640C	N/A	219040	Small Cam series w/ 2 belt pulley, 5 1/4" impeller w/WP638 pump & IP638 idler & adj. bolt included	GK638

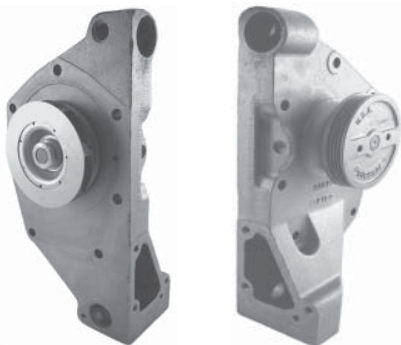

**88NT  
WP644  
Core Class 518**

Part#	OEM#	Casting#	Description	Gasket Kit
WP644	303136, 303138	3062899	Big Cam IV, narrow poly groove pulley, stamped steel impeller	GK644



## Heavy Duty Diesel Engine Water Pumps Visual Identification Guide

### Cummins V Series Engine



**V, VT555**  
**WP667, WP668, WP669**  
Core Class 522

Part#	OEM#	Casting#	Description	Gasket Kit
WP667	AR61788, A-34079-A05	555260	V-6 155, V-8 210 Engines	n/a
WP668	AR61116	553928	V, VT555V-8 Series (made in U.K.)	n/a
WP669	3014476	3014462	V, VT555V-8 Series w/2 belt pulley	n/a

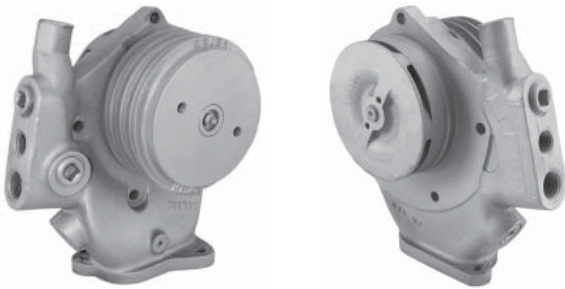

**V, VT903**  
**WP670**  
Core Class 513

Part#	OEM#	Casting#	Description	Gasket Kit
WP670	AR5664	196960	V-8 series, 3 belt pulley	GK670

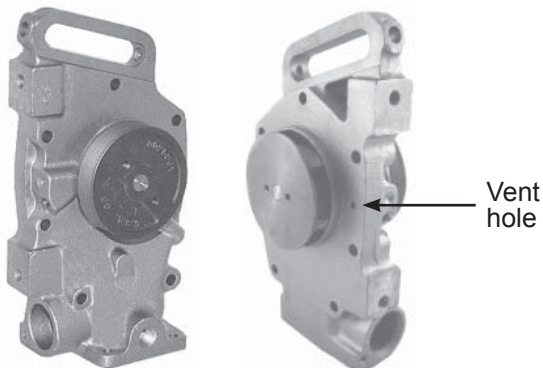

**300, 350, 400, Fleet 300, NTC Formula**  
**300, 350, 400, NTC475**  
**WP636**  
Core Class 510

Part#	OEM#	Casting#	Description	Gasket Kit
WP636	3801708, 3045943	3045163	Big Cam IV Low RPM Engine, w/ 4" poly groove pulley, 4 1/2" impeller, 1/4" vent hole	GK638

## Heavy Duty Diesel Engine Water Pumps Visual Identification Guide

### Detroit Diesel 50 & 60 Series

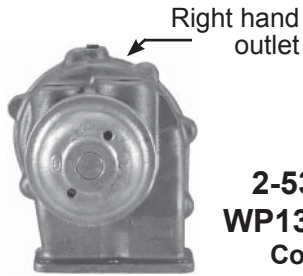

**2-53, 3-53, 4-53**  
**WP1387, WP1387A**  
Core Class 531

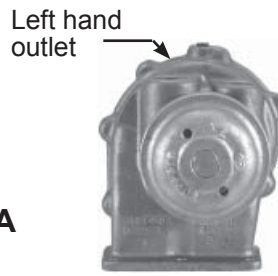

Part#	OEM#	Casting#	Description	Gasket Kit
WP1387	5144686	5144889	Right hand outlet, 2 threaded ports	GK1388
WP1387A	5109046	5119281	Right hand outlet, 1 threaded port	GK1388
WP1388	5144685	5144688	Left hand outlet, 2 threaded ports	GK1388
WP1388A	5109551	5119280	Left hand outlet, 1 threaded port	GK1388

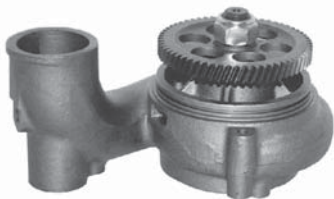

**60 Series**  
**WP1400**  
Core Class 542



**60 Series**  
**WP1408, WP1409**  
Core Class 542

Part#	OEM#	Casting#	Description	Gasket Kit
WP1400	8929509, 23509067, 23514989	8929511, 23505018	Gear driven with one outlet	GK1400
WP1408	23517028	23517027	2nd series gear driven with 2 outlets; w/ 3/8" pipe thread outlet for high horsepower 470 & up only	GK1409
WP1409	23505895, 23514990, 23516416	23505894, 23516417	2nd series gear driven with 2 outlets; w/ 1/4" pipe thread outlet	GK1409

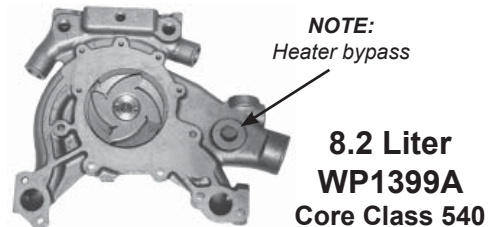
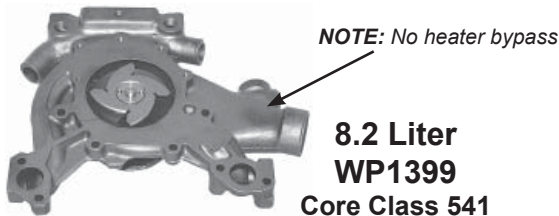

Part#	OEM#	Casting#	Description	Core Class
WP1399	8922302	8820383	Early style without heater bypass	GK1399
WP1399A	8927158, 8928672	8924657, 8926904, 40-181(aftermarket)	Late style with heater bypass	GK1399

# Heavy Duty Diesel Engine Water Pumps

## Visual Identification Guide

### Detroit Diesel 71 Series



**Inline 71 Series**  
**WP1257\***, **WP601**  
 Core Class 533      Core Class 535



**Inline 71 Series**  
**WP1257A\*\***, **WP601A**  
 Core Class 532      Core Class 534

Part#	OEM#	Casting#	Description	Gasket Kit
WP1257	5149707, 5135596, 5159060, 5186576	5186574, 5178318, 5135602	Inline 71 engine; right hand out- let, standard capacity(shown)	GK1257
WP1257A	5149706, 5150439, 5159059, 5186575, 5135595	5178317, 5186573, 5135601	Inline 71 engine; left hand outlet, standard capacity(shown)	GK1257
WP601	5149708, 8920916	5182070, 8920918, 5135611	Inline 71 engine; right hand outlet, high capacity	GK601
WP601A	5149710, 8920915	5182069, 8920917	Inline 71 engine; left hand outlet, high capacity	GK601

\* **Note:** Also 50, 60, 65 series, GMC 6-71, Series 450-900 3-71, 4-71, 6-71 Engines.

\*\* **Note:** Also 50, 60, 65 series, GMC 6-71, V-6, V 6-71 Engines.

### High Capacity / Standard Capacity Impellers

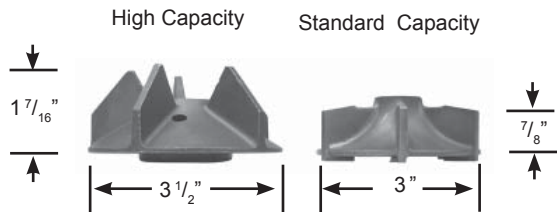

# Heavy Duty Diesel Engine Water Pumps

## Visual Identification Guide

### Detroit Diesel 71 Series

#### V-71 Engines

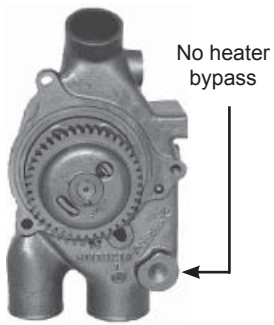

**WP1394**  
Core Class 536

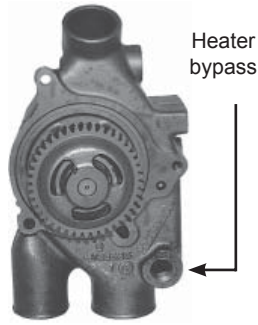

**WP1395, WP1395R**  
Core Class 536

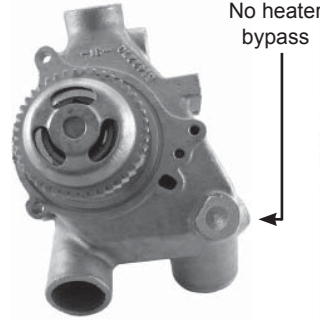

**WP1396, WP1396A, WP1396R**  
Core Class 537

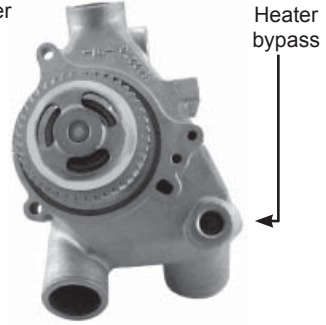

Part#	OEM#	Casting#	Description	Gasket Kit
WP1394	5149328	5106160, 5117921, 5135455	V-6 & V-8 engines; standard capacity, "standing" w/o heater bypass	GK1395
WP1395	5149326, 23506790	5117921, 5135455	V-6 & V-8 engines; high capacity, "standing" with heater bypass	GK1395
WP1396	5149329	5134621, 5142273	V-6 & V-8 eng.; standard capacity, "running" w/o heater bypass& rear cover plate	GK1395
WP1396A	5149327	5142273	V-8 engines; high capacity, "running" with heater bypass	GK1395
WP1395R	5149382	5117921, 5135455	V-8 engines; high capacity, "standing" with heater bypass & reverse gear	GK1395
WP1396R	5149327	5142273	V-8 engines; high capacity, "running" with heater bypass & reverse gear	GK1395

### Detroit Diesel 92 Series

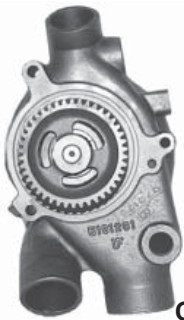

**WP1395A**  
Core Class 539



**WP1397**  
Core Class 539

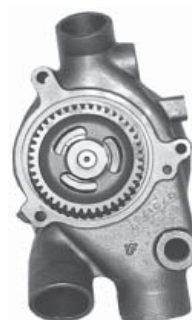

**WP1395AR**  
Core Class 539

Part#	OEM#	Casting#	Description	Gasket Kit
WP1395A	8921105, 8922336	5101261, 892100, 8922325	V-6 & V-8 engines; "walking", Note: 3 weep hole styles	GK1395
WP1397	8921104, 8922335	5101162, 8921099, 8922326	V-6 & V-8 engines; "running", Note: 3 weep hole styles	GK1395
WP1395AR	8921104, 8922335		V-6 & V-8 engines; "walking", w/ reverse gear	GK1395

## Heavy Duty Diesel Engine Water Pumps Visual Identification Guide

### Ford E & F 250-350, F Super Duty, F53/F59 Stripped



**WP1577**  
Core Class 566



**WP1579**  
Core Class 566



**WP1581**  
Core Class 566

Part#	OEM#	Casting#	Description	Gasket Kit
WP1577	F6TZ-8505ARM, F6TZ-8505BRM	1823611C1, 1823611C2	V-8 w/466 (7.3L) Direct injection turbo diesel (2nd & 3rd design late '94)	GK1474
WP1579	F4TZ-8501ARM	1818182C3, 1818182C4	V-8 w/446 (7.3L) Direct injection turbo diesel (First design '94 only)	GK1479
WP1581	F5TZ-8501ARM	1822823C1, 1823611C2	V-8 w/446 (7.3L) Direct injection turbo diesel ('96-'95)	GK1581



**WP1566**  
Core Class 539



**WP1576**  
Core Class 539



Discharge tube for WP1576 &  
Wp1577 available separately

Part#	OEM#	Casting#	Description	Gasket Kit
WP1566	F7TZ-8501ARM, 991919C91	1823423C2	F Super Duty F53/F59 stripped V-8 w/446 (7.3L) Turbo diesel (4th design)	TBA
WP1576	F81Z-8505ARM, F81Z-8505AARM	1831005C2	E & F 250-350, V-8 w/466 (7.3L) Direct injection	TBA

### Ford E & F 250-350

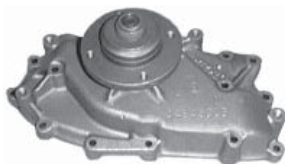

**WP560F**  
Core Class 539

Part#	OEM#	Casting#	Description	Gasket Kit
WP560F	E4TZ-8501C, E9TZ-8501B	446430C1, 446430C2, 446430C4	V-8 w/420 (6.9L) (88-83) & 446 (7.3L) (94-83) Diesel Engines, w/threaded hub	GK560

## Heavy Duty Diesel Engine Water Pumps Visual Identification Guide

### Ford Truck: Medium & Heavy Duty



**WP1595**  
Core Class 571



**WP1598**  
Core Class 576



**WP1599**  
Core Class 576

Part#	OEM#	Casting#	Description	Gasket Kit
WP1595	D9HZ-8501A, E2HZ-8501B, E5HZ-8501A, F1HZ-8501E, F5HZ-8501AA	D9TE-8505CC, E2TE-8505AA, E4TE-AA, F1HE-8505CA, F5HE-8505AA	B, C, CT, F, L, LN, LNS, LT, LTS600-800 (97-79); V-8 w/370, 429 engines	TBA
WP1598	F1HZ-8501D,	E8HN-8508AB	B, C, CF, F, FT, L600-800 (95-91); 6 Cyl. w/401 (6.6L) &476 (7.8L) w/water pump mounted fan (exc. 210 H.P.	GK1594
WP1599	F1HZ-8501C	F0HN-8508AA		GK1594



**WP682**  
Core Class 528



**WP683**  
Core Class 529

Part#	OEM#	Casting#	Description	Gasket Kit
WP682	F3HZ-8501ARM	3928395	B, C, CF, F, L600-900 (97-90); 6 Cyl. 5.9L FD1060 Cummins diesel engine	n/a
WP683	F3HZ-8501BRM	3905357	B, C, CF, F, L700-900 (97-90); 6 Cyl. 8.3L FD1460 Cummins diesel engine	n/a



**WP1594**  
Core Class 576



**WP1597**  
Core Class 576



Part#	OEM#	Casting#	Description	Gasket Kit
WP1594	E7HZ-8501B, E8HZ-8501B	E6HN-8508AA, E7HN-8508AA	B, F,L 600-800 (91-87); 6 Cyl. w/401 (6.6, 476 (7.8L) diesel eng., 3/4" outlet	GK1594
WP1597	N/A	E5HN-8508AB	Brazilian, CF 6 Cyl. w/7.8L diesel engine, 1" outlet	GK1594
WP1593	E7HZ-8501B	E6HN-8508AA	6 cyl. w/476 (7.8L) diesel engine No longer available. Use WP1594	GK1594

## Heavy Duty Diesel Engine Water Pumps Visual Identification Guide

### IHC / Navistar

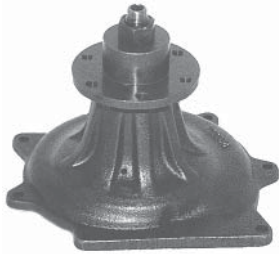

**WP563**  
Core Class 561

Part#	OEM#	Casting#	Description	Gasket Kit
WP563	680899C91, C92, C93	677137C1	Cab over w/DT466 engine; bolt on hub	GK563

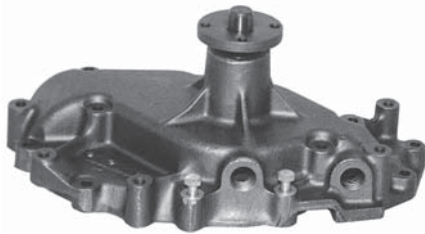

**WP560**  
Core Class 562

Part#	OEM#	Casting#	Description	Gasket Kit
WP560	1805951C91, 1805952C91, 1809374C91	446430C1, 446430C2, 446430C4	Cargostar, Loadstar, S series w/ 420 (6.9L) diesel or 404, 446 gas engine, (w/small 2 5/8" non-threaded hub)	GK560

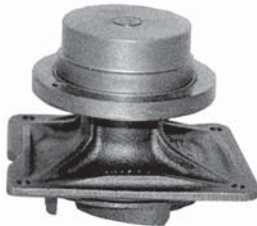

**WP1479**  
Core Class 564

Part#	OEM#	Casting#	Description	Gasket Kit
WP1479	1700594C91	489173C1	Cargostar, S series w/ 9.0L) diesel engine; press on hub	GK1479

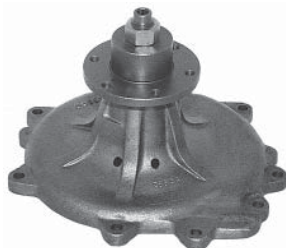

**WP563A**  
Core Class 560

Part#	OEM#	Casting#	Description	Gasket Kit
WP563A	685155C91, C92, C95	677856C1, C2	S series Conventional cab w/ DT466 engine	GK563A
WP565	1815538C91	677856C3	Various models w/ DT360 diesel engine; w/left hand thread & 1" thick hub	GK563A

## Heavy Duty Diesel Engine Water Pumps Visual Identification Guide

### *IHC / Navistar*



**WP568**  
Core Class 565



Part#	OEM#	Casting#	Description	Gasket Kit
WP568	817687C92	1821935C91	Various w/6 cylinder DT360/466 New Generation diesel engines; stamped steel impeller.	TBA



**WP559**  
Core Class 566

Part#	OEM#	Casting#	Description	Gasket Kit
WP559	1823669C92	1822851C1	Various w/6 cylinder DT444E diesel engine; screw on filter	TBA



## Heavy Duty Diesel Engine Water Pumps Visual Identification Guide

### Mack Truck

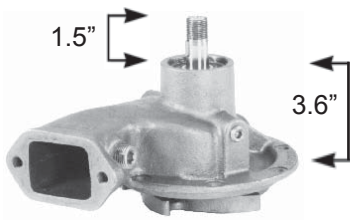

**WP794**  
Core Class 550

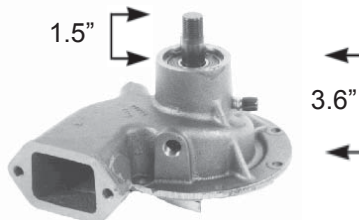

**WP794S**  
Core Class 550

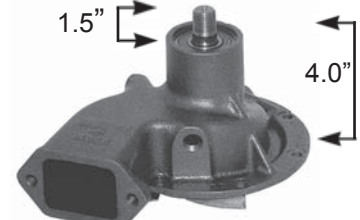

**WP794B & WP794BS**  
Core Class 551

Part#	OEM#	Casting#	Description	Gasket Kit
WP794	316GC184	360GB454	B61, B65 6 cylinder diesel engine; w/o hub & w/ cast impeller	GK1210
WP794S	316GC184	360GB454	H61, 63, 75 6 cylinder diesel engine; w/o hub & with stamped steel impeller	GK1210
WP794B	316GC1184	360GB343, 360GB443	ENDT675 (Maxidyne) w/ cast impeller	GK1210
WP794BS	316GC1184	360GB343, 360GB443	ENDT675 (Maxidyne) w/ stamped steel impeller	GK1210

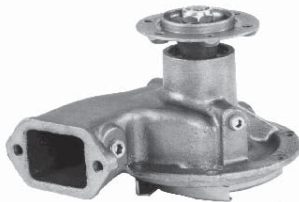

**WP794WH**  
Core Class 558

Part#	OEM#	Casting#	Description	Gasket Kit
WP794WH	316GC184N	360GB325	END673 6 cylinder diesel engine; w/Hub	TBA

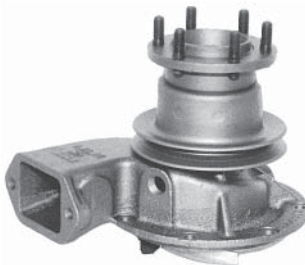

**WP1184**  
Core Class 553



**WP1211**  
Core Class 555

Part#	OEM#	Casting#	Description	Gasket Kit
WP1184	316GC184H	360GB443	END675 (Maxidyne) w/1st style hub & AC pulley	GK1210
WP1211	316GC1211A	360GB443	END675 (Maxidyne) w/2nd style hub & AC pulley	GK1210

## Heavy Duty Diesel Engine Water Pumps Visual Identification Guide

### Mack Truck



**WP1210NP**  
Core Class 552

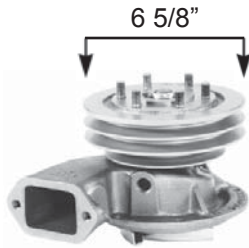

**WP1210**  
Core Class 559

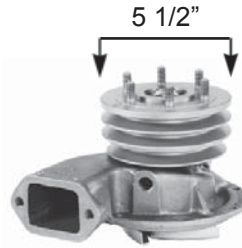

**WP528**  
Core Class 559

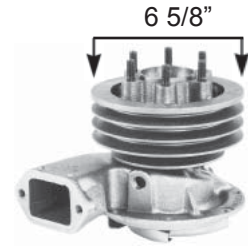

**WP1184B**  
Core Class 559

Part#	OEM#	Casting#	Description	Gasket Kit
WP1210NP	316GC1210	360GB443	END675ESI (EMS6) w/ short shaft w/o pulley	GK1210
WP1210	316GC1210A	360GB443	END675ESI (EMS6) w/ 3 belt 6 5/8" cast pulley	GK1210
WP528	316GC528A	360GB443	END675ESI (EMS6) w/ 3 belt 5 1/2" cast pulley	GK1210
WP1184B	316GC1184BP2	360GB443	END675ESI (EMS6) w/ 4 belt 6 5/8" cast pulley	GK1210

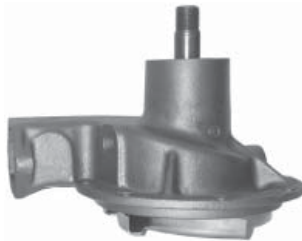

**WP1219**  
Core Class 554

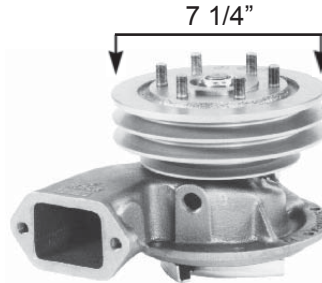

**WP1229**  
Core Class 559

Part#	OEM#	Casting#	Description	Gasket Kit
WP1219	316GC1219, 316GC1219A	360GB443A	E7 w/ flat bottom & stamped impeller	GK1210
WP1229	316GC549MX	360GB443A	E7 w/ flat bottom & stamped impeller; 3 groove pulley (same as WP1219 w/pulley)	GK1210

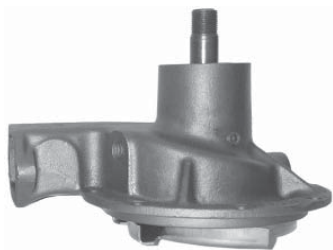

**WP1230**  
Core Class 554

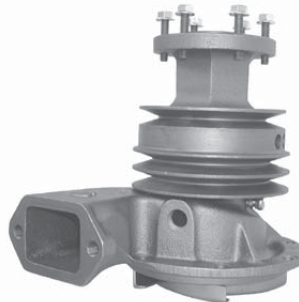

**WP1232**  
Core Class 559

Part#	OEM#	Casting#	Description	Gasket Kit
WP1230	316GC284	360GB1251AM	E7 w/ metric housing & stamped impeller	GK1210
WP1232	316GC4107MX	360GB1251AM	E7 w/ metric housing & stamped impeller (same as WP1230 w/3 belt pulley)	GK1210

## Heavy Duty Diesel Engine Water Pumps Visual Identification Guide

### Mack Truck

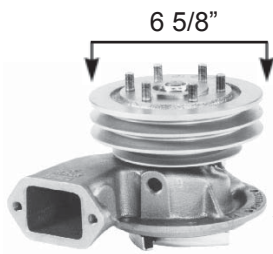

**WP1233**  
Core Class 559



**WP1234**  
Core Class 559

Part#	OEM#	Casting#	Description	Gasket Kit
WP1233	316GC548M4X	360GB1251AM	E7 w/ 3 groove pulley & stamped impeller (pulley# 302GC459, 499)	GK1210
WP1234	316GC4108MX	360GB1251AM	E7 w/ 6 5/8" 3 groove pulley & stamped impeller (pulley# 302GC462M)	GK1210



**WP1236**  
Core Class 559

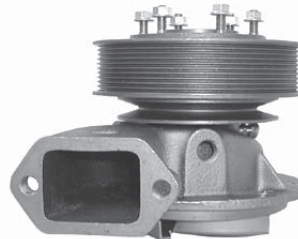

**WP1237**  
Core Class 559

Part#	OEM#	Casting#	Description	Gasket Kit
WP1236	316GC551M2X	360GB1251AM	E7 w/ multi-groove pulley & stamped impeller (5 1/2" metric housing)	GK1210
WP1237	316GC551MX	360GB1251AM	E7 w/ multi-groove pulley & stamped impeller (pulley# 302GC476M)	GK1210

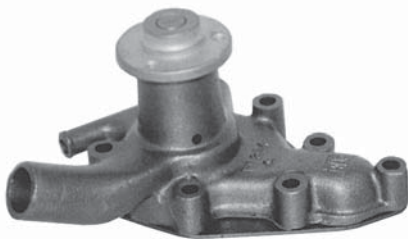

**WP1199**  
Core Class 580



**WP1200**  
Core Class 580

### Thermo King

Part#	OEM#	Casting#	Description	Gasket Kit
WP1199	11-4576	BTK, PH374	C201PT 4cyl. Isuzu 2207CC engine (Note: Units w/ bearing lock - no core value)	GK1199
WP1200	11-5858	M1, M2, M3	C220 4cyl. Isuzu 2.2 liter engine	GK1200



# **SECTION 3**

## **CROSS REFERENCES**

### **TABLE OF CONTENTS**

<b>CASTING NUMBERS TO PRECISION.....</b>	<b>3-2 to 3-11</b>
<b>OEM NUMBERS TO PRECISION.....</b>	<b>3-12 to 3-16</b>
<b>COMPETITIVE NUMBERS TO PRECISION .....</b>	<b>3-17 to 3-20</b>

## Cross Reference

### Casting Number to Water Pump Number by Casting Number

Casting #	Manufacturer	Part #	Casting #	Manufacturer	Part #
0080283	Massey-Ferg.	WP293	14024206	Chev./GMC	WP1623
0080283	Massey/Perk.	WP293A	14024206	Chev./GMC	WP1628
100-7479	Caterpillar	WP1016	140472H	IHC	WP132
1003A7	Diamond Reo	WP273A	1407-A7	Diamond Reo	WP276
10044305	Chev./GMC	WP1634	1407-A8	Diamond Reo	WP278
1008478	Massey-Ferg.	WP298	14102026	Chev./GMC	WP1627
10105828	Chev./GMC	WP1627	145305	IHC/Navistar	WP132
10108451	Chev./GMC	WP1627	150018	Cummins	WP634A
10108453	Chev./GMC	WP1575	151203R1	IHC/Navistar	WP1552
10108457	Chev./GMC	WP1639	151203R1	IHC/Navistar	WP573
10114105	Chev./GMC	WP1626	151203R1	IHC/Navistar	WP573S
10124623	Chev./GMC	WP1634	151203R1M	IHC/Navistar	WP550
10166843	Chev./GMC	WP1626	154180	Cummins	WP741A
10191700	Chev./GMC	WP1590	154964	Cummins	WP632
101953	Cummins	WP740	154964	Cummins	WP632A
102-5946	Caterpillar	WP1006	157398	Cummins	WP634
10238199	Chev./GMC	WP1640	157398	Cummins	WP634A
10240915	Chev./GMC	WP1626	165135	Cummins	WP631
103-0745	Caterpillar	WP1011	165135	Cummins	WP631A
105-4213	Caterpillar	WP1019	165135	Cummins	WP631AA
105-4214	Caterpillar	WP1019	169204R1	IHC/Agro	WP571
105181	Allis Chalmers	WP250	169204R1	IHC/Navistar	WP1244A
105288	Cummins	WP741	1750303M91	Massey/Cont.	WP1243
105781	Cummins	WP742	180160C	Oliver	WP269
1072A734	Caterpillar	WP1000	1818182C3	Ford Truck	WP1579
108317	Allis Chalmers	WP251	1818182C4	Ford Truck	WP1579
110166	Case	WP253	1821935C91	IHC/Navistar	WP568
115481	Cummins	WP630	1821935C1	IHC/Navistar	WP568
115481	Cummins	WP630A	1821935C3	IHC/Navistar	WP568
115498	Cummins	WP631	1822823C1	Ford Truck	WP1581
115498	Cummins	WP631A	1822851C1	IHC/Navistar	WP559
115498	Cummins	WP631AA	1823423C2	Ford	WP1566
117001	Chrysler Ind.	WP580F	1823611C1	Ford	WP1577
121982	Allis Chalmers	WP250	1823611C2	Ford	WP1577
12553486	Chev./GMC	WP1635	1831676C91	IHC/Navistar	WP559
12554747	Chev./GMC	WP1533	185108	Cummins	WP687
12557071	Chev./GMC	WP1635	185109	Cummins	WP688
125577	Allis Chalmers	WP251	1852063	Massey	WP1284
126035	Allis Chalmers	WP266	1852065	Chrysler Ind.	WP580H
129433	Allis Chalmers	WP249	1859582	Chrysler Ind.	WP580H
1295-A7	Diamond Reo	WP273A	186-1	Case	WP258
130175	Cummins	WP633	190360	Oliver	WP268
130175	Cummins	WP633A	196830	Cummins	WP633
131680	Mack	WP799	196830	Cummins	WP633A
131732	Cummins	WP632	196845	Cummins	WP632
131732	Cummins	WP632A	196845	Cummins	WP632A
132414	Cummins	WP635	196930	Cummins	WP670
132423	Cummins	WP630	196960	Cummins	WP670
132423	Cummins	WP630A	1W4619	Caterpillar	WP1008A
1326322	Massey	WP1284	1W4619	Caterpillar	WP1008B
1327138	Chrysler Ind.	WP580H	1W4619	Caterpillar	WP1012
1334-A7	Diamond Reo	WP272A	1W4619	Caterpillar	WP1013
133523R2	IHC	WP134	1W9619	Caterpillar	WP1013
134445	Allis Chalmers	WP1447	1W5664	Caterpillar	WP1002
134680	Allis Chalmers	WP1450	1W6558	Caterpillar	WP1014
1362010110	Thermo-King	WP1605	2001584	Chev./GMC	WP1578
1393-A7	Diamond Reo	WP276A	2014-11	Case	WP258
14001939	Chev./GMC	WP1590	202963	Cummins	WP633B
14001939	Chev./GMC	WP1591	206964	Cummins	WP739

## Cross Reference

### Casting Number to Water Pump Number by Casting Number

Casting #	Manufacturer	Part #	Casting #	Manufacturer	Part #
208118	Cummins	IP640	3064201	Cummins	IP644
210238	Cummins	WP639	3064201R	Cummins	IP644
210238	Cummins	WP640	3064920	Cummins	IP640
210238	Cummins	WP640A	3069644	Cummins	WP689
210238	Cummins	WP641	3072355	Cummins	IP689
210238	Cummins	WP645	3076523	Cummins	WP689
210238	Cummins	WP684	30994	Ford	WP1511
2128284	Chrysler/Mas.	WP1349	30998	Chev./GMC	WP1534
214408R1	IHC/Navistar	WP574	3132677R2	IHC/Agro	WP564
215397	Cummins	IP638	3132677R4	IHC/Agro	WP564
21600-1	Ford	WP1592	3132677R4	IHC/Agro	WP566
218274	Cummins	WP638	3132677R4	IHC/Agro	WP567
218274	Cummins	WP638B	3171	Chev./GMC	WP1430
218274	Cummins	WP638C	3171	Chev./GMC	WP1436
218274	Cummins	WP642	318118R4	IHC/Navistar	WP571
219040	Cummins	WP639	328581	Chev./GMC	WP1633
219040	Cummins	WP640	329673	Chev./GMC	WP1625
219040	Cummins	WP640C	330813	Chev./GMC	WP1534
219040	Cummins	WP641	330813P	Chev./GMC	WP1534
219040	Cummins	WP645	352199	Chev./GMC	WP1624
219040	Cummins	WP684	35220001	Mercedes	WP1601
23500372	Chev./GMC	WP1628	3522003801	Mercedes	WP1602
23500372	Chev./GMC	WP1629	3522010201	Mercedes	WP1601
23505018	Detroit	WP1400	3522011901	Mercedes	WP1601
23505894	Detroit	WP1409	3527002301	Mercedes	WP1601
23516417	Detroit	WP1409	355763R91	IHC	WP260
23517027	Detroit	WP1408	360GB121	Mack	WP792
2374896	Chev./GMC	WP575	360GB238	Mack	WP795
2475787	Chev./GMC	WP1430	360GB241	Mack	WP787
2475787	Chev./GMC	WP1436	360GB251AM	Mack	WP1227
2532906	Chrysler Ind.	WP1351	360GB251AM	Mack	WP1228
281761C2	IHC/Navistar	WP1478	360GB251AM	Mack	WP1230
281761C2	IHC/Navistar	WP1478NP	360GB251AM	Mack	WP1232
2843290	Chrysler Ind.	WP1496	360GB251AM	Mack	WP1233
2863007	Chrysler Ind.	WP1440	360GB251AM	Mack	WP1234
2863063	Chrysler/Mas.	WP1349	360GB251AM	Mack	WP1236
2863067	Chrysler Ind.	WP1440	360GB251AM	Mack	WP1237
2883663	Chrysler/Mas.	WP1349	360GB31	Mack	WP675
295-1	Chrysler Ind.	WP580H	360GB325	Mack	WP794
2P761	Caterpillar	WP1008	360GB325	Mack	WP794S
3002520	Cummins	WP646	360GB325	Mack	WP794WH
3002520	Cummins	WP646MG	360GB326	Mack	WP793
3004745	Cummins	WP680	360GB334	Mack	WP794A
30114	Ford	WP1522	360GB334	Mack	WP794
30115	Ford	WP1521	360GB334	Mack	WP794S
3014462	Cummins	WP669	360GB334	Mack	WP794WH
3031802	Cummins	WP637	360GB343	Mack	WP794B
303394R1	IHC/Navistar	WP571	360GB343	Mack	WP794BS
3034316	Cummins	IP637	360GB420	Mack	WP791
3035157	Cummins	WP637	360GB427	Mack	WP797
3036877	Cummins	WP645	360GB438	Mack	WP798
3039182	Cummins	WP637	360GB443	Mack	WP1184
3045163	Cummins	WP636	360GB443	Mack	WP1184B
3046809	Cummins	IP644B	360GB443	Mack	WP1210
30511	Chev./GMC	WP442	360GB443	Mack	360GB443A
3060883	Cummins	IP671	360GB443	Mack	WP1211
3060884	Cummins	IP671	360GB443	Mack	WP1219
3062693	Cummins	IP644	360GB443	Mack	WP528
3062899	Cummins	WP644	360GB443	Mack	WP794B

## Cross Reference

### Casting Number to Water Pump Number by Casting Number

Casting #	Manufacturer	Part #	Casting #	Manufacturer	Part #
360GB443	Mack	WP794BS	446430C2	Ford	WP560F
360GB443A	Mack	WP794B	446430C2	IHC/Navistar	WP560
360GB443A	Mack	WP794BS	446430C4	Ford	WP560F
360GB443A	Mack	WP1210NP	446430C4	IHC/Navistar	WP560
360GB443A	Mack	WP1210	45021	Buda	WP576
360GB443A	Mack	WP528	465802	Chev./GMC	WP1624
360GB443A	Mack	WP1221	465802	Chev./GMC	WP1630
360GB443A	Mack	WP1184B	489173C1	IHC/Navistar	WP1479
360GB443A	Mack	WP1184	4N1137	Caterpillar	WP1006
360GB443A	Mack	WP1211	4N1941	Caterpillar	WP1009
360GB443A	Mack	WP1219	4P8681	Caterpillar	WP1020
360GB443A	Mack	WP1229	4P8681	Caterpillar	WP1021
360GB468	Mack	WP673	500020160	Mack/Renault	WP810
360GB47	Mack	WP789	50020168	Mack/Renault	WP810
36784R1	IHC Agro	WP139	5101162	Detroit	WP1397
376444	Chev./GMC	WP1575	5101261	Detroit	WP1395A
37711260	Massey/Perk.	WP293A	5101802	Detroit	TBA
37711260	Perkins	WP293	5106160	Detroit	WP1394
37711320	Perkins	WP624	5106180	Detroit	WP1394
37711330	Perkins	WP1464	5117921	Detroit	WP1394
37711330	Perkins	WP1464A	5117921	Detroit	WP1395
37711330B	Perkins	WP1464	5117921	Detroit	WP1395R
37711330B	Perkins	WP1464A	5117970	Detroit	WP1378
37711331	Massey/Perk.	WP1464	5119280	Detroit	WP1388A
37711331	Massey/Perk.	WP1464A	5119281	Detroit	WP1387A
37711390	Perkins	WP1465	5130701	Detroit	WP1404
37711630	Perkins	WP1462	5134355	Detroit	WP1402
37711690	Perkins	WP1461	5134621	Detroit	WP1396
37711690	Perkins	WP1461A	5135455	Detroit	WP1394
37712330	Perkins	WP1466	5135455	Detroit	WP1395
37712540	Massey/Perk.	WP1463	5135455	Detroit	WP1395R
3788476	Chev./GMC	WP1625	5135601	Detroit	WP1257A
3789537	Massey/GMC	WP442	5135602	Detroit	WP1257
3802051	Cummins	WP683	5135611	Detroit	WP601
38399175	Massey/GMC	WP1500	5136455	Detroit	WP1395
3856284	Chev./GMC	WP1501	5136455	Detroit	WP1394
3856286	Chev./GMC	WP1446	5142273	Detroit	WP1396
3858288	Chev./GMC	WP1446	5142273	Detroit	WP1396A
3859326	Chev./GMC	WP1500	5142273	Detroit	WP1396R
3861922	Massey/GMC	WP1633	5142758	Detroit	WP1401
3868320	Chev./GMC	WP1500	5144688	Detroit	WP1388
3882615	Cummins	WP671	5144889	Detroit	WP1387
3903357	Cummins	WP683	5145089	Detroit	WP1379
3913432	Cummins	WP681	5178317	Detroit	WP1257A
3913439	Cummins	WP683	5178318	Detroit	WP1257
3920310	Cummins	WP682	518040	Chev./GMC	WP1430
3920311	Cummins	WP682	518040	Chev./GMC	WP1436
3920312	Cummins	WP682	5182069	Detroit	WP601A
3924141	Cummins	WP682	5182070	Detroit	WP601
3928396	Cummins	WP682	5182119	Detroit	WP1403
3992077	Chev./GMC	WP1501	5186573	Detroit	WP1257A
40-181	Detroit	WP1399A	5186574	Detroit	WP1257
4025063	Allis Chalmers	WP1448	553928	Cummins	WP668
4026091	Allis Chalmers	WP1448	555260	Cummins	WP667
4028129	Allis Chalmers	WP305	5577A	Case	WP254
406R1	John Deere	WP425	56000280263BM	Mack/Renault	WP811
4095700	Chrysler Ind.	WP1349	56000280263BM	Mack/Renault	WP812
446430C1	Ford	WP560F	5631A	Case	WP253
446430C1	IHC/Navistar	WP560	5S6664	Caterpillar	WP1015



## Cross Reference

### Casting Number to Water Pump Number by Casting Number

Casting #	Manufacturer	Part #	Casting #	Manufacturer	Part #
6263707	Chev./GMC	WP1533	B241	Buda/Co-op	WP583
6362010110	Thermo-King	WP1605	B244	Buda/Co-op	WP583
637437	Chrysler/Mas.	WP580H	B2886R	John Deere	WP289
675802C2	IHC/Agro	WP563B	B3407R	John Deere	WP286
675806C2	IHC/Agro	WP563C	B829	Buda	WP576
675806C2	IHC/Agro	WP563B	B829	Buda/Co-op	WP583
675806C3	IHC/Agro	WP563B	BTK	Thermo King	WP1199
675806C3	IHC/Agro	WP563C	C1TE-8503A	Ford	WP1328
677137C1	IHC/Navistar	WP563	C3TE-8505B	Ford	WP1513
677856C1	IHC/Navistar	WP563A	C4SE-8505	Ford	WP1519
677856C1	IHC/Navistar	WP565	C4TE-8505C	Ford	WP1416
677856C2	IHC/Navistar	WP563A	C4TE-8505D	Ford	WP1415
677856C3	IHC/Navistar	WP565	C5AE-8505A	Ford	WP1515
677858C2	IHC/Agro	WP563C	C5AZ-8505E	Ford	WP1435
69495R11	IHC/Navistar	WP1244	C5DE-8505A	Ford Ind.	WP1350
6N8413	Caterpillar	WP1010	C5NE-8505A	Ford Agro	WP1477
770GB418A	Mack	WP284A	C5NE-8508A	Ford Agro	WP1474
771GB444	Mack	WP790	C5TE-8505A	Ford	WP1460
771GB454	Mack	WP790A	C5TE-8505B	Ford	WP1460
7E855401	Caterpillar	WP1011	C5TE-8505G	Ford	WP1460
7N7800DX	Caterpillar	WP1002	C6AE-8505B	Ford	WP1515
7N196	Caterpillar	WP1013	C7AE-8505A	Ford	WP1435
859582	Chrysler Ind.	WP580F	C7TE-8505B	Ford	WP1416
869035	Chrysler Ind.	WP580F	C8AE-8505D	Ford	WP1515
87522R11	IHC	WP131A	C8AE-8505H	Ford	WP1515
8820383	Detroit	WP1399	C8AE-8505K	Ford	WP1435
8828804	Detroit	WP1399A	C8DE-8505B	Ford Ind.	WP1350
883AM	Case	WP254	C8TE-8505B	Ford	WP1329A
8920383	Detroit	WP1399	C8TE-8505E	Ford	WP1416
8920917	Detroit	WP601A	C8TE-8505E	Ford	WP1544
8920918	Detroit	WP601	C8TE-8505F	Ford	WP1415
8920925	Detroit	WP1257	C8TE-8505F	Ford	WP1527
8921099	Detroit	WP1397	C8TE-8505G	Ford	WP1509
8921100	Detroit	WP1395A	C8TE-8508B	Ford	WP1328
8922325	Detroit	WP1395A	C8TE-8508B	Ford	WP1329
8922326	Detroit	WP1397	C9AE-8505A	Ford	WP1515
8924657	Detroit	WP1399A	C9TE-8505C	Ford	WP1502
8926904	Detroit	WP1399A	D0OE-8505D	Ford	WP1502
8929511	Detroit	WP1400	D0TE-8505C	Ford	WP1528
8N5796	Caterpillar	WP1002	D0TE-8505C	Ford	WP1529
8RT-8505	Ford	WP1522	D2AE-8505A	Ford	WP1435
8RT-8506	Ford	WP1521	D2TE-8505AA	Ford	WP1509
93412618	Chev./GMC	WP1630	D2TE-8505AA	Ford	WP1511
98445H	IHC	WP132	D2TE-8505AA	Ford	WP1543
9L2279	Caterpillar	WP1002	D2TE-8505AA	Ford	WP1548
9L7505	Caterpillar	WP1000	D2VE-8505BA	Ford	WP1535
9L8323	Caterpillar	WP1001	D3TE-8505BB	Ford	WP1572
9N-8505	Ford/Massey	WP1290	D3TE-8505CB	Ford	WP1527
9N138	Caterpillar	WP1000	D3TE-8505CB	Ford	WP1571
9N3076	Caterpillar	WP1000T	D4TE-8505A2A	Ford	WP1515
9N3076	Caterpillar	WP1003T	D4TE-8505BB	Ford	WP1497
9N3076	Caterpillar	WP1003TF	D5HE-8508AA	Ford	WP1580
9N5034	Caterpillar	WP1006	D5HE-8508AA	Ford	WP1596
9N5034-01	Caterpillar	WP1016	D5NN-8505A	Ford Agro	WP1474A
9Y4361	Caterpillar	WP1011	D5TE-8505DA	Ford	WP1574
A-28860	Case	WP258	D5TE-8505EA	Ford	WP1518
A26112	Case	WP254	D5TE-8505EA	Ford	WP1569
A5318R	John Deere	WP285	D5TE-8505EA	Ford	WP1573
B241	Buda	WP576	D5VE-8505AA	Ford	WP1535

## Cross Reference

### Casting Number to Water Pump Number by Casting Number

Casting #	Manufacturer	Part #	Casting #	Manufacturer	Part #
D7TE-8505AA	Ford	WP1502	PH374	Thermo King	WP1199
D8TE-8505AA	Ford	WP1574	R26326R	John Deere	WP406
D8UE-8505AA	Ford	WP1535	R26337R	John Deere	WP407
D9TE-8505CC	Ford	WP1595	R26337R	John Deere	WP426
E2TE-8505AA	Ford	WP1595	R27547R	John Deere	WP405
E3TE-8505D	Ford	WP1511	R34981R	John Deere	WP416
E3TE-8505DA	Ford	WP1510	R34982	John Deere	WP415
E3TE-8505DA	Ford	WP1548	R41315	John Deere	WP408
E4TE-AA	Ford	WP1595	R48992	John Deere	WP431
E5HN-8508AA	Ford	WP1589	R48997	John Deere	WP431
E5HN-8508AB	Ford	WP1597	R50408	John Deere	WP430
E5ZE-8505AA	Ford	WP1567	R54051	John Deere	WP431
E6HN-8508AA	Ford	WP1593	R55758	John Deere	WP431
E7HN-8508AA	Ford	WP1594	R55971	John Deere	WP432
E7HN-8508AB	Ford	WP1597	R56813	John Deere	WP432
E8HN-8508AB	Ford	WP1598	R60533	John Deere	WP433
E9TE-8505AA	Ford	WP1567	R62190	John Deere	WP434
E9TE-8505A4A	Ford	WP1567	R70612	John Deere	WP435
E9TE-8505DA	Ford	WP1510	R73508	John Deere	WP435
EAF-8505	Ford	WP1291	R74445	John Deere	WP434
EAF-8505A	Ford	WP1291	T-5400	Buda	WP576
EAF-8505B	Ford	WP1291	VT341	Case	WP258
EAF-8505C	Ford	WP1291	Y400K335	Continental	WP579
EBP-8505A	Ford	WP1513	Y400K410	Continental	WP664
ECW-8505A	Ford	WP1520	Z129K-402	Continental	WP1295
EDL-8508	Ford	WP1328	Z129K-402	Massey/Cont.	WP287
EDL-8508	Ford	WP1329			
EDL-8508A	Ford	WP1328			
F0HN-8508AA	Ford	WP1599			
F0TE-8505BA	Ford	WP1510			
F0TE-8505BA	Ford	WP1585			
F1HE-8505CA	Ford	WP1595			
F1TE-8505CA	Ford	WP1535			
F2TE-8505AA	Ford	WP1566A			
F2TE-8505AA	Ford	WP1584			
F3UE-8505AA	Ford	WP1549			
F400K413	Continental	WP584			
F400K418	Continental	WP585			
F400K422	Continental	WP586			
F400K422	Continental	WP586A			
F400K422	Continental	WP662			
F400K422	Continental	WP663			
F400K423	Continental	WP587			
F400K423	Continental	WP587A			
F4TE-8505AA	Ford	WP1549			
F4TE-8505BA	Ford	WP1583			
F5HE-8505AA	Ford	WP1595			
F600K506	Continental	WP578			
F6TE-8505LA	Ford	WP1549			
G11854	Case	WP302			
G11854	Case	WP307			
G2075	Case	WP302			
G2075	Case	WP307			
H509688	Buda	WP576			
J403K-402	Massey-Ferg.	WP288			
L126627	Allis Chalmers	WP252			
M1	Thermo King	WP1200			
M2	Thermo King	WP1200			
M3	Thermo King	WP1200			

## Cross Reference

### Casting Number to Water Pump Number by Casting Number

Casting #	Manufacturer	Part #	Casting #	Manufacturer	Part #
105181	Allis Chalmers	WP250	9L8323	Caterpillar	WP1001
108317	Allis Chalmers	WP251	9N138	Caterpillar	WP1000
121982	Allis Chalmers	WP250	9N3076	Caterpillar	WP1000T
125577	Allis Chalmers	WP251	9N3076	Caterpillar	WP1003T
126035	Allis Chalmers	WP266	9N3076	Caterpillar	WP1003TF
129433	Allis Chalmers	WP249	9N5034	Caterpillar	WP1006
134445	Allis Chalmers	WP1447	9N5034-01	Caterpillar	WP1016
134680	Allis Chalmers	WP1450	9Y4361	Caterpillar	WP1011
4025063	Allis Chalmers	WP1448	10044305	Chev./GMC	WP1634
4026091	Allis Chalmers	WP1448	10105828	Chev./GMC	WP1627
4028129	Allis Chalmers	WP305	10108451	Chev./GMC	WP1627
L126627	Allis Chalmers	WP252	10108453	Chev./GMC	WP1575
45021	Buda	WP576	10108457	Chev./GMC	WP1639
B241	Buda	WP576	10114105	Chev./GMC	WP1626
B829	Buda	WP576	10124623	Chev./GMC	WP1634
H509688	Buda	WP576	10166843	Chev./GMC	WP1626
T-5400	Buda	WP576	10191700	Chev./GMC	WP1590
B241	Buda/Co-op	WP583	10238199	Chev./GMC	WP1640
B244	Buda/Co-op	WP583	10240915	Chev./GMC	WP1626
B829	Buda/Co-op	WP583	12553486	Chev./GMC	WP1635
110166	Case	WP253	12554747	Chev./GMC	WP1533
186-1	Case	WP258	12557071	Chev./GMC	WP1635
2014-11	Case	WP258	14001939	Chev./GMC	WP1590
5577A	Case	WP254	14001939	Chev./GMC	WP1591
5631A	Case	WP253	14024206	Chev./GMC	WP1623
883AM	Case	WP254	14024206	Chev./GMC	WP1628
A26112	Case	WP254	14102026	Chev./GMC	WP1627
A-28860	Case	WP258	2001584	Chev./GMC	WP1578
G11854	Case	WP302	23500372	Chev./GMC	WP1628
G11854	Case	WP307	23500372	Chev./GMC	WP1629
G2075	Case	WP302	2374896	Chev./GMC	WP575
G2075	Case	WP307	2475787	Chev./GMC	WP1430
VT341	Case	WP258	2475787	Chev./GMC	WP1436
100-7479	Caterpillar	WP1016	30511	Chev./GMC	WP442
102-5946	Caterpillar	WP1006	30998	Chev./GMC	WP1534
103-0745	Caterpillar	WP1011	3171	Chev./GMC	WP1430
105-4213	Caterpillar	WP1019	3171	Chev./GMC	WP1436
105-4214	Caterpillar	WP1019	328581	Chev./GMC	WP1633
1072A734	Caterpillar	WP1000	329673	Chev./GMC	WP1625
1W4619	Caterpillar	WP1008A	330813	Chev./GMC	WP1534
1W4619	Caterpillar	WP1008B	330813P	Chev./GMC	WP1534
1W4619	Caterpillar	WP1012	352199	Chev./GMC	WP1624
1W4619	Caterpillar	WP1013	376444	Chev./GMC	WP1575
1W5664	Caterpillar	WP1002	3788476	Chev./GMC	WP1625
1W6558	Caterpillar	WP1014	3856284	Chev./GMC	WP1501
1W9619	Caterpillar	WP1013	3856286	Chev./GMC	WP1446
2P761	Caterpillar	WP1008	3858288	Chev./GMC	WP1446
4N1137	Caterpillar	WP1006	3859326	Chev./GMC	WP1500
4N1941	Caterpillar	WP1009	3868320	Chev./GMC	WP1500
4P8681	Caterpillar	WP1020	3992077	Chev./GMC	WP1501
4P8681	Caterpillar	WP1021	465802	Chev./GMC	WP1624
5S6664	Caterpillar	WP1015	465802	Chev./GMC	WP1630
6N8413	Caterpillar	WP1010	518040	Chev./GMC	WP1430
7E855401	Caterpillar	WP1011	518040	Chev./GMC	WP1436
7N196	Caterpillar	WP1013	6263707	Chev./GMC	WP1533
7N7800DX	Caterpillar	WP1002	93412618	Chev./GMC	WP1630
8N5796	Caterpillar	WP1002	117001	Chrysler Ind.	WP580F
9L2279	Caterpillar	WP1002	1327138	Chrysler Ind.	WP580H
9L7505	Caterpillar	WP1000	1852065	Chrysler Ind.	WP580H

## Cross Reference

### Casting Number to Water Pump Number by Casting Number

Casting #	Manufacturer	Part #	Casting #	Manufacturer	Part #
1859582	Chrysler Ind.	WP580H	208118	Cummins	IP640
2532906	Chrysler Ind.	WP1351	210238	Cummins	WP639
2843290	Chrysler Ind.	WP1496	210238	Cummins	WP640
2863007	Chrysler Ind.	WP1440	210238	Cummins	WP640A
2863067	Chrysler Ind.	WP1440	210238	Cummins	WP641
295-1	Chrysler Ind.	WP580H	210238	Cummins	WP645
4095700	Chrysler Ind.	WP1349	210238	Cummins	WP684
859582	Chrysler Ind.	WP580F	215397	Cummins	IP638
869035	Chrysler Ind.	WP580F	218274	Cummins	WP638
2128284	Chrysler/Mas.	WP1349	218274	Cummins	WP638A
2863063	Chrysler/Mas.	WP1349	218274	Cummins	WP638B
2883663	Chrysler/Mas.	WP1349	218274	Cummins	WP638C
637437	Chrysler/Mas.	WP580H	218274	Cummins	WP642
F400K413	Continental	WP584	219040	Cummins	WP639
F400K418	Continental	WP585	219040	Cummins	WP640
F400K422	Continental	WP586	219040	Cummins	WP640C
F400K422	Continental	WP586A	219040	Cummins	WP641
F400K422	Continental	WP662	219040	Cummins	WP645
F400K422	Continental	WP663	219040	Cummins	WP684
F400K423	Continental	WP587	3002520	Cummins	WP646
F400K423	Continental	WP587A	3002520	Cummins	WP646MG
F600K506	Continental	WP578	3004745	Cummins	WP680
Y400K335	Continental	WP579	3014462	Cummins	WP669
Y400K410	Continental	WP664	3031802	Cummins	WP637
Z129K-402	Continental	WP1295	3034316	Cummins	IP637
101953	Cummins	WP740	3035157	Cummins	WP637
105288	Cummins	WP741	3036877	Cummins	WP645
105781	Cummins	WP742	3039182	Cummins	WP637
115481	Cummins	WP630	3045163	Cummins	WP636
115481	Cummins	WP630A	3045163	Cummins	WP638A
115498	Cummins	WP631	3046809	Cummins	IP644B
115498	Cummins	WP631A	3060883	Cummins	IP671
115498	Cummins	WP631AA	3060884	Cummins	IP671
130175	Cummins	WP633	3062693	Cummins	IP644
130175	Cummins	WP633A	3062899	Cummins	WP644
131732	Cummins	WP632	3064201	Cummins	IP644
131732	Cummins	WP632A	3064201R	Cummins	IP637
132414	Cummins	WP635	3064201R	Cummins	IP644
132423	Cummins	WP630	3064920	Cummins	IP640
132423	Cummins	WP630A	3069644	Cummins	WP689
150018	Cummins	WP634A	3072355	Cummins	IP689
154180	Cummins	WP741A	3076523	Cummins	WP689
154964	Cummins	WP632	3802051	Cummins	WP683
154964	Cummins	WP632A	3882615	Cummins	WP671
157398	Cummins	WP634	3903357	Cummins	WP683
157398	Cummins	WP634A	3903357	Cummins	WP682
165135	Cummins	WP631	3903657	Cummins	WP681
165135	Cummins	WP631A	3905357	Cummins	WP683
165135	Cummins	WP631AA	3913432	Cummins	WP681
185108	Cummins	WP687	3913439	Cummins	WP683
185109	Cummins	WP688	3920310	Cummins	WP682
196830	Cummins	WP633	3920311	Cummins	WP682
196830	Cummins	WP633A	3920312	Cummins	WP682
196845	Cummins	WP632	3924141	Cummins	WP682
196845	Cummins	WP632A	3928396	Cummins	WP682
196930	Cummins	WP670	553928	Cummins	WP668
196960	Cummins	WP670	555260	Cummins	WP667
202963	Cummins	WP633B	AR8851	Cummins	IP640
206964	Cummins	WP739	23505018	Detroit	WP1400

## Cross Reference

### Casting Number to Water Pump Number by Casting Number

Casting #	Manufacturer	Part #	Casting #	Manufacturer	Part #
23505894	Detroit	WP1409	1334-A7	Diamond Reo	WP272A
23516417	Detroit	WP1409	1393-A7	Diamond Reo	WP276A
23517027	Detroit	WP1409	1407-A7	Diamond Reo	WP276
23517027	Detroit	WP1408	1407-A8	Diamond Reo	WP278
40-181	Detroit	WP1399A	1823423C2	Ford	WP1566
5101162	Detroit	WP1397	1823611C1	Ford	WP1577
5101261	Detroit	WP1395A	1823611C2	Ford	WP1577
5101802	Detroit	Call	21600-1	Ford	WP1592
5106160	Detroit	WP1394	30114	Ford	WP1522
5106160	Detroit	WP1395	30115	Ford	WP1521
5106180	Detroit	WP1394	30994	Ford	WP1511
5106180	Detroit	WP1395	446430C1	Ford	WP560F
5117921	Detroit	WP1394	446430C2	Ford	WP560F
5117921	Detroit	WP1395	446430C4	Ford	WP560F
5117921	Detroit	WP1395R	8RT-8505	Ford	WP1522
5117970	Detroit	WP1378	8RT-8506	Ford	WP1521
5119280	Detroit	WP1388A	C1TE-8503A	Ford	WP1328
5119281	Detroit	WP1387A	C3TE-8505B	Ford	WP1513
5130701	Detroit	WP1404	C4SE-8505	Ford	WP1519
5134355	Detroit	WP1402	C4TE-8505C	Ford	WP1416
5134621	Detroit	WP1396	C4TE-8505D	Ford	WP1415
5135455	Detroit	WP1394	C5AE-8505A	Ford	WP1515
5135455	Detroit	WP1395	C5AZ-8505E	Ford	WP1435
5135455	Detroit	WP1395R	C5TE-8505A	Ford	WP1460
5135601	Detroit	WP1257A	C5TE-8505B	Ford	WP1460
5135602	Detroit	WP1257	C5TE-8505G	Ford	WP1460
5135611	Detroit	WP601	C6AE-8505B	Ford	WP1515
5136455	Detroit	WP1395	C7AE-8505A	Ford	WP1435
5136455	Detroit	WP1394	C7TE-8505B	Ford	WP1416
5142273	Detroit	WP1396	C8AE-8505D	Ford	WP1515
5142273	Detroit	WP1396A	C8AE-8505H	Ford	WP1515
5142273	Detroit	WP1396R	C8AE-8505K	Ford	WP1435
5142758	Detroit	WP1401	C8TE-8505B	Ford	WP1329A
5144688	Detroit	WP1388	C8TE-8505E	Ford	WP1416
5144889	Detroit	WP1387	C8TE-8505E	Ford	WP1544
5145089	Detroit	WP1379	C8TE-8505F	Ford	WP1415
5149707	Detroit	WP1257	C8TE-8505F	Ford	WP1527
5178317	Detroit	WP1257A	C8TE-8505G	Ford	WP1509
5178318	Detroit	WP1257	C8TE-8508B	Ford	WP1328
5182069	Detroit	WP601A	C8TE-8508B	Ford	WP1329
5182070	Detroit	WP601	C9AE-8505A	Ford	WP1515
5182119	Detroit	WP1403	C9TE-8505C	Ford	WP1502
5186573	Detroit	WP1257A	D0OE-8505D	Ford	WP1502
5186574	Detroit	WP1257	D0TE-8505C	Ford	WP1528
8820383	Detroit	WP1399	D0TE-8505C	Ford	WP1529
8828804	Detroit	WP1399A	D2AE-8505A	Ford	WP1435
8920383	Detroit	WP1399	D2TE-8505AA	Ford	WP1509
8920917	Detroit	WP601A	D2TE-8505AA	Ford	WP1511
8920918	Detroit	WP601	D2TE-8505AA	Ford	WP1543
8920925	Detroit	WP1257	D2TE-8505AA	Ford	WP1548
8921099	Detroit	WP1397	D2VE-8505BA	Ford	WP1535
8921100	Detroit	WP1395A	D3TE-8505BB	Ford	WP1572
8922325	Detroit	WP1395A	D3TE-8505CB	Ford	WP1527
8922326	Detroit	WP1397	D3TE-8505CB	Ford	WP1571
8924657	Detroit	WP1399A	D4TE-8505A2A	Ford	WP1515
8926904	Detroit	WP1399A	D4TE-8505BB	Ford	WP1497
8929511	Detroit	WP1400	D5HE-8508AA	Ford	WP1580
1003A7	Diamond Reo	WP273A	D5HE-8508AA	Ford	WP1596
1295-A7	Diamond Reo	WP273A	D5TE-8505DA	Ford	WP1574

## Cross Reference

### Casting Number to Water Pump Number by Casting Number

Casting #	Manufacturer	Part #	Casting #	Manufacturer	Part #
D5TE-8505EA	Ford	WP1518	36784R1	IHC Agro	WP139
D5TE-8505EA	Ford	WP1569	169204R1	IHC/Agro	WP571
D5TE-8505EA	Ford	WP1573	3132677R2	IHC/Agro	WP564
D5VE-8505AA	Ford	WP1535	3132677R4	IHC/Agro	WP564
D7TE-8505AA	Ford	WP1502	3132677R4	IHC/Agro	WP566
D8TE-8505AA	Ford	WP1574	3132677R4	IHC/Agro	WP567
D8UE-8505AA	Ford	WP1535	675802C2	IHC/Agro	WP563B
D9HZE8505CC	Ford	WP1595	675806C2	IHC/Agro	WP563C
D9TE-8505CC	Ford	WP1595	675806C2	IHC/Agro	WP563B
E2TE-8505AA	Ford	WP1595	675806C3	IHC/Agro	WP563B
E3TE-8505D	Ford	WP1511	675806C3	IHC/Agro	WP563C
E3TE-8505DA	Ford	WP1510	677858C2	IHC/Agro	WP563C
E3TE-8505DA	Ford	WP1548	145305	IHC/Navistar	WP132
E4TE-AA	Ford	WP1595	151203R1	IHC/Navistar	WP1552
E5HN-8508AA	Ford	WP1589	151203R1	IHC/Navistar	WP573
E5HN-8508AB	Ford	WP1597	151203R1	IHC/Navistar	WP573S
E5ZE-8505AA	Ford	WP1567	151203R1M	IHC/Navistar	WP550
E6HN-8508AA	Ford	WP1593	169204R1	IHC/Navistar	WP1244A
E7HN-8508AA	Ford	WP1594	1821935C1	IHC/Navistar	WP568
E7HN-8508AB	Ford	WP1597	1821935C3	IHC/Navistar	WP568
E8HN-8508AB	Ford	WP1598	1821935C91	IHC/Navistar	WP568
E9TE-8505A4A	Ford	WP1567	1822851C1	IHC/Navistar	WP559
E9TE-8505AA	Ford	WP1567	1831676C91	IHC/Navistar	WP559
E9TE-8505DA	Ford	WP1510	214408R1	IHC/Navistar	WP574
EAF-8505	Ford	WP1291	281761C2	IHC/Navistar	WP1478
EAF-8505A	Ford	WP1291	281761C2	IHC/Navistar	WP1478NP
EAF-8505B	Ford	WP1291	303394R1	IHC/Navistar	WP571
EAF-8505C	Ford	WP1291	318118R4	IHC/Navistar	WP571
EBP-8505A	Ford	WP1513	446430C1	IHC/Navistar	WP560
ECW-8505A	Ford	WP1520	446430C2	IHC/Navistar	WP560
EDL-8508	Ford	WP1328	446430C4	IHC/Navistar	WP560
EDL-8508	Ford	WP1329	489173C1	IHC/Navistar	WP1479
EDL-8508A	Ford	WP1328	677137C1	IHC/Navistar	WP563
F0HN-8508AA	Ford	WP1599	677856C1	IHC/Navistar	WP563A
F0TE-8505BA	Ford	WP1510	677856C1	IHC/Navistar	WP565
F0TE-8505BA	Ford	WP1585	677856C2	IHC/Navistar	WP563A
F1HE-8505CA	Ford	WP1595	677856C3	IHC/Navistar	WP565
F1TE-8505CA	Ford	WP1535	69495R11	IHC/Navistar	WP1244
F2TE-8505AA	Ford	WP1566	406R1	John Deere	WP425
F2TE-8505AA	Ford	WP1584	A5318R	John Deere	WP285
F3UE-8505AA	Ford	WP1549	B2886R	John Deere	WP289
F4TE-8505AA	Ford	WP1549	B3407R	John Deere	WP286
F4TE-8505BA	Ford	WP1583	R26326R	John Deere	WP406
F5HE-8505AA	Ford	WP1595	R26337R	John Deere	WP407
F6TE-8505LA	Ford	WP1549	R26337R	John Deere	WP426
C5NE-8505A	Ford Agro	WP1477	R27547R	John Deere	WP405
C5NE-8508A	Ford Agro	WP1474	R34981R	John Deere	WP416
D5NN-8505A	Ford Agro	WP1474A	R34982	John Deere	WP415
C5DE-8505A	Ford Ind.	WP1350	R41315	John Deere	WP408
C8DE-8505B	Ford Ind.	WP1350	R48992	John Deere	WP431
1818182C3	Ford Truck	WP1579	R48997	John Deere	WP431
1818182C4	Ford Truck	WP1579	R50408	John Deere	WP430
1822823C1	Ford Truck	WP1581	R54051	John Deere	WP431
9N-8505	Ford/Massey	WP1290	R55758	John Deere	WP431
133523R2	IHC	WP134	R55971	John Deere	WP432
140472H	IHC	WP132	R56813	John Deere	WP432
355763R91	IHC	WP260	R60533	John Deere	WP433
87522R11	IHC	WP131A	R62190	John Deere	WP434
98445H	IHC	WP132	R70612	John Deere	WP435

## Cross Reference

### Casting Number to Water Pump Number by Casting Number

Casting #	Manufacturer	Part #	Casting #	Manufacturer	Part #
R73508	John Deere	WP435	1750303M91	Massey/Cont.	WP1243
R74445	John Deere	WP434	Z129K-402	Massey/Cont.	WP287
131680	Mack	WP799	3789537	Massey/GMC	WP442
360GB121	Mack	WP792	38399175	Massey/GMC	WP1500
360GB238	Mack	WP795	3861922	Massey/GMC	WP1633
360GB241	Mack	WP787	0080283	Massey/Perk.	WP293A
360GB251AM	Mack	WP1227	37711260	Massey/Perk.	WP293A
360GB251AM	Mack	WP1228	37711331	Massey/Perk.	WP1464
360GB251AM	Mack	WP1230	37711331	Massey/Perk.	WP1464A
360GB251AM	Mack	WP1232	37712540	Massey/Perk.	WP1463
360GB251AM	Mack	WP1233	0080283	Massey-Ferg.	WP293
360GB251AM	Mack	WP1234	1008478	Massey-Ferg.	WP298
360GB251AM	Mack	WP1236	J403K-402	Massey-Ferg.	WP288
360GB251AM	Mack	WP1237	35220001	Mercedes	WP1601
360GB31	Mack	WP675	3522003801	Mercedes	WP1602
360GB325	Mack	WP794	3522010201	Mercedes	WP1601
360GB325	Mack	WP794S	3522011901	Mercedes	WP1601
360GB325	Mack	WP794WH	3527002301	Mercedes	WP1601
360GB326	Mack	WP793	180160C	Oliver	WP269
360GB334	Mack	WP794A	190360	Oliver	WP268
360GB334	Mack	WP794	37711260	Perkins	WP293
360GB334	Mack	WP794S	37711320	Perkins	WP624
360GB334	Mack	WP794WH	37711330	Perkins	WP1464
360GB343	Mack	WP794B	37711330	Perkins	WP1464A
360GB343	Mack	WP794BS	37711330B	Perkins	WP1464
360GB420	Mack	WP791	37711330B	Perkins	WP1464A
360GB427	Mack	WP797	37711390	Perkins	WP1465
360GB438	Mack	WP798	37711630	Perkins	WP1462
360GB443	Mack	WP1184	37711690	Perkins	WP1461
360GB443	Mack	WP1184B	37711690	Perkins	WP1461A
360GB443	Mack	WP1210	37712330	Perkins	WP1466
360GB443	Mack	360GB443A	BTK	Thermo King	WP1199
360GB443	Mack	WP1211	M1	Thermo King	WP1200
360GB443	Mack	WP1219	M2	Thermo King	WP1200
360GB443	Mack	WP528	M3	Thermo King	WP1200
360GB443	Mack	WP794B	PH374	Thermo King	WP1199
360GB443	Mack	WP794BS	1362010110	Thermo-King	WP1605
360GB443A	Mack	WP794B	6362010110	Thermo-King	WP1605
360GB443A	Mack	WP794BS			
360GB443A	Mack	360GB443A			
360GB443A	Mack	WP1210			
360GB443A	Mack	WP528			
360GB443A	Mack	WP1221			
360GB443A	Mack	WP1184B			
360GB443A	Mack	WP1184			
360GB443A	Mack	WP1211			
360GB443A	Mack	WP1219			
360GB443A	Mack	WP1229			
360GB468	Mack	WP673			
360GB47	Mack	WP789			
770GB418A	Mack	WP284A			
771GB444	Mack	WP790			
771GB454	Mack	WP790A			
500020160	Mack/Renault	WP810			
50020168	Mack/Renault	WP810			
56000280263BM	Mack/Renault	WP811			
56000280263BM	Mack/Renault	WP812			
1326322	Massey	WP1284			
1852063	Massey	WP1284			

## Cross Reference

### OEM Number to Water Pump Number by Manufacturer

OEM #	Manufacturer	Part #	OEM #	Manufacturer	Part #
100-9344	Caterpillar	WP1016	1809374C91	IHC/Navistar	WP560
10046305	Chev./GMC	WP1630	1812001201	Mercedes/TK	WP1605
10048917	Chev./GMC	WP1575	1815538C91	IHC/Navistar	WP565
10048921	Chev./GMC	WP1534	1817687C92	IHC/Navistar	WP568
1005011M91	Massey-Ferg.	WP298	1817687C95	IHC/Navistar	WP568
1006944	Caterpillar	WP1019	1823669C92	IHC/Navistar	WP559
10074182	Chev./GMC	WP1591	1W3058	Caterpillar	WP1012
10077059	Chev./GMC	WP1627	1W3060	Caterpillar	WP1008B
10081980	Chev./GMC	WP1626	20854-3	Cummins	WP740
10140667	Chev./GMC	WP1590	218150R91	IHC/Navistar	WP574
1025282M91	Massey/GMC	WP442	2196910	Chrysler Ind.	WP1349
1025844	Caterpillar	WP1011	2235969	Chev./GMC	WP575
1032473M91	Massey/GMC	WP1500	2340256	Chev./GMC	WP442
1035836M91	Massey/GMC	WP1500	23500133	Chev./GMC	WP1623
1064750	Chrysler/Mas.	WP580H	23501938	Detroit	WP1394
1064925	Chrysler Ind.	WP580F	23501939	Detroit	WP1396
11-4576	Thermo King	WP1199	23505019	Detroit	WP1400
11-4642	Thermo-King	WP1605	23505895	Detroit	WP1409
11-5858	Thermo King	WP1200	23506003	Detroit	WP1388
12514269	Chev./GMC	WP1623	23506007	Detroit	WP1387
12514574	Chev./GMC	WP1629	23506204	Detroit	WP601A
12520263	Chev./GMC	WP1590	23506602	Detroit	WP1395A
12521037	Chev./GMC	WP1626	23506623	Detroit	WP1397
12522031	Chev./GMC	WP1627	23506670	Detroit	WP1395R
12522032	Chev./GMC	WP1627	23506698	Detroit	WP1396R
12522033	Chev./GMC	WP1575	23506711	Detroit	WP601
12522036	Chev./GMC	WP1639	23506723	Detroit	WP1557A
12525123	Chev./GMC	WP1626	23506735	Detroit	WP1257
12527759	Chev./GMC	WP1626	23506763	Detroit	WP1379
12528917	Chev./GMC	WP1640	23506790	Detroit	WP1395
12529192	Chev./GMC	WP1590	23506791	Detroit	WP1396A
12529308	Chev./GMC	WP1639	23509067	Detroit	WP1400
12530176	Chev./GMC	WP1635	23514989	Detroit	WP1400
12532528	Chev./GMC	WP1640	23514990	Detroit	WP1409
12534772	Chev./GMC	WP1635	23516416	Detroit	WP1409
12551474	Chev./GMC	WP1590	23517028	Detroit	WP1408
133493R92	IHC	WP134	23518215	Detroit	WP1408
14002440	Chev./GMC	WP1591	23522707	Detroit	WP1408
14061698	Chev./GMC	WP1623	2384840	Chev./GMC	WP575
14085852	Chev./GMC	WP1533	2417197	Chev./GMC	WP1430
14087581	Chev./GMC	WP1501	2417197	Chev./GMC	WP1436
1501926M91	Chrysler/Mas.	WP580H	2475788	Chev./GMC	WP1430
1504002M91	Chrysler/Mas.	WP580H	2475788	Chev./GMC	WP1436
1509862M91	Massey	WP1284	250396	Allis Chal.	WP251
15633465	Chev./GMC	WP1623	250397	Allis Chal.	WP266
15633466	Chev./GMC	WP1628	260540C92	IHC/Navistar	WP1244A
1600743	Diamond Reo	WP273A	270918C92	IHC/Navistar	WP1552
1601537	Diamond Reo	WP276A	270918C92	IHC/Navistar	WP573
1601926	Diamond Reo	WP272A	2808679	Chrysler Ind.	WP1349
1602437	Diamond Reo	WP276	2808680	Chrysler Ind.	WP1496
1602581	Diamond Reo	WP278	297359C93	IHC/Navistar	WP1478NB
1603326	Chrysler Ind.	WP580H	2N-8501	Ford	WP1290
162899AS	Oliver	WP268	2P0661	Caterpillar	WP1010
162900AS	Oliver	WP269	2P0662	Caterpillar	WP1008
170027R91	IHC/Navistar	WP1244A	2W1223	Caterpillar	WP1002
1700594C91	IHC/Navistar	WP1479	2W1225	Caterpillar	WP1003T
1700594C92	IHC/Navistar	WP1479	2W1227	Caterpillar	WP1003TF
1752677	Chrysler Ind.	WP580F	2W3277	Caterpillar	WP1006
1805951C91	IHC/Navistar	WP560	2W8001	Caterpillar	WP1008B
1805952C91	IHC/Navistar	WP560	2W8002	Caterpillar	WP1013
			2W8003	Caterpillar	WP1014



## Cross Reference

### OEM Number to Water Pump Number by Manufacturer

OEM #	Manufacturer	Part #	OEM #	Manufacturer	Part #
3000886	Cummins	WP640	316GC235	Mack	WP790
3000896	Cummins	WP640A	316GC236	Mack	WP791
3003731	Cummins	WP681	316GC239	Mack	WP793
3004715	Chrysler Ind.	WP1351	316GC245	Mack	WP797
3004762	Chrysler Ind.	WP1440	316GC259A	Mack	WP798
3004923	Cummins	WP638	316GC284	Mack	WP1230
3004991	Chrysler Ind.	WP1440	316GC284A	Mack	WP284A
3007290	Cummins	WP639	316GC4107MX	Mack	WP1232
3014476	Cummins	WP669	316GC4108MX	Mack	WP1234
3022471	Cummins	WP646	316GC523BX	Mack	WP1221
3022472	Cummins	WP638	316GC528A	Mack	WP528
3022474	Cummins	WP638	316GC528CX	Mack	WP528
3022920	Cummins	WP739	316GC548M2X	Mack	WP1227
3024671	Cummins	WP684	316GC548M4X	Mack	WP1233
3027174	Cummins	WP638	316GC548MX	Mack	WP1228
3027882	Cummins	WP646MG	316GC549MX	Mack	WP1229
303395R91	IHC/Agro	WP571	316GC551M2X	Mack	WP1236
303395R92	IHC/Navistar	WP571	316GC551MX	Mack	WP1237
3034969	Cummins	IP637	318119R92	IHC/Navistar	WP571
3036876	Cummins	WP638	338059	Mack/Ren.	WP810
3045161	Cummins	WP642	3420050	Chrysler/Mas.	WP1349
3045943	Cummins	WP636	3522009401	Mercedes	WP1601
3045943RX	Cummins	WP636	3552000101	Mercedes	WP1602
3051368	Cummins	WP680	355760R93	IHC	WP260
3051384	Cummins	WP638	357261	Chev./GMC	WP1625
3051408	Cummins	WP638	357262	Chev./GMC	WP1624
3052836	Cummins	WP644	357621C92	IHC/Navistar	WP550
3053537	Cummins	IP644	368496R91	IHC/Agro	WP571
3062602	Cummins	IP671	3789536	Chev./GMC	WP442
3062693	Cummins	IP644	3801234	Cummins	IP644
3062928	Cummins	WP644	3801708	Cummins	WP636
3062930	Cummins	IP644B	3801713	Cummins	WP646
3062931	Cummins	IP644	3801715	Cummins	WP640
3064919	Cummins	IP638	3801784	Cummins	WP640
3064920	Cummins	IP640	3801788	Cummins	WP638
3065000	Cummins	IP644A	3801840	Cummins	WP637
3066330	Cummins	IP689	3802004	Cummins	WP681
3132676R93	IHC/Agro	WP564	3802061	Cummins	WP683
3136053R92	IHC/Agro	WP567	3802081	Cummins	WP683
3136217R92	IHC/Agro	WP566	3802358	Cummins	WP681
316GC1151	Mack	WP795	3802970	Cummins	WP682
316GC1179	Mack	WP787	3803030	Cummins	WP644
316GC1184	Mack	WP794B	3803136	Cummins	WP644
316GC1184B	Mack	WP794BS	3803138	Cummins	WP644
316GC1184BP2X	Mack	WP1184B	3803361	Cummins	WP689
316GC1184BX	Mack	WP1184	3803402	Cummins	WP637
316GC1210A	Mack	WP1210	3803403	Cummins	WP671
316GC1210AX	Mack	WP1210	3803605	Cummins	WP689
316GC1211A	Mack	WA1211	3804883RX	Cummins	WP683
316GC1211AX	Mack	WP1211	3815726	Chev./GMC	WP1625
316GC1211B	Mack	WP794BS	3876168	Chev./GMC	WP1625
316GC1219	Mack	WP1219	3876172	Chev./GMC	WP1633
316GC1219A	Mack	WP1219	3903749	Cummins	WP682
316GC133	Mack	WP673	3905357	Cummins	WP683
316GC149	Mack	WP675	3913430	Cummins	WP683
316GC150	Mack	WP792	3913432	Cummins	WP682
316GC174B	Mack	WP790A	3927564	Chev./GMC	WP1501
316GC184	Mack	WP794	3927565	Chev./GMC	WP1578
316GC184H	Mack	WP794A	3928395	Cummins	WP682
316GC184N	Mack	WP794WH	3928396	Cummins	WP682
316GC22C	Mack	WP789	3947042	Chev./GMC	WP1625

## Cross Reference

### OEM Number to Water Pump Number by Manufacturer

OEM #	Manufacturer	Part #	OEM #	Manufacturer	Part #
3947051	Massey/GMC	WP1633	5178318	Detroit	WP1257
3957981	Chev./GMC	WP1500	5178658	Detroit	WP1387
3990992	Chev./GMC	WP1446	5186575	Detroit/Oliver	WP1257A
3998206	Chev./GMC	WP1500	5186576	Detroit	WP1257
3998207	Chev./GMC	WP1500	5S6684	Caterpillar	WP1015
41035000338059X	Mack/Ren.	WP810	601816C91	IHC/Agro	WP571
41312154	Perkins	WP1464A	6258119	Chev./GMC	WP1633
41312159	Perkins	WP1464	6258446	Chev./GMC	WP1625
41312167	Perkins	WP293A	6258548	Chev./GMC	WP1446
41312248	Perkins	WP1461	6258551	Chev./GMC	WP1534
41312487	Massey/Perk.	WP1464	663009	Mack/Renault	WP811
41312506	Perkins	WP1462	670157	Mack/Renault	WP812
41312518	Massey/Perk.	WP299	673162C92	IHC/Agro	WP563B
41312574	Perkins	WP293A	673162C94	IHC/Agro	WP563B
41312892	Massey-Ferg.	WP293	673623C92	IHC/Agro	WP563C
41312892	Massey-Ferg.	WP293A	680899C91	IHC/Navistar	WP563
41313018	Perkins	WP624	680899C92	IHC/Navistar	WP563
4429404	Cummins	WP681	680899C93	IHC/Navistar	WP563
448087C92	IHC/Navistar	WP1478	685155C91	IHC/Navistar	WP563A
463365C91	IHC/Navistar	WP1552	685155C92	IHC/Navistar	WP563A
465475.2	Volvo	WP1610	685155C94	IHC/Navistar	WP563A
465542.9	Volvo	WP1610	685155C95	IHC/Navistar	WP563A
466756	Volvo	WP1611	6I3890	Caterpillar	WP1016
466833.1	Volvo	WP1611	6N8413	Caterpillar	WP1013
474029	Chev./GMC	WP1575	731807M91	Perkins	WP293
474055	Chev./GMC	WP1630	731807M91	Massey-Ferg.	WP293A
474056	Chev./GMC	WP1624	734527M91	Massey/Perk.	WP1464A
4N7415	Caterpillar	WP1006	734932M91	Massey/Perk.	WP1464A
4N7498	Caterpillar	WP1009	735036M91	Massey/Perk.	WP1464
4P3683	Caterpillar	WP1020	735327C91	Navistar Reman	WP563A
4W0253	Caterpillar	WP1020	735445C91	Navistar Reman	WP565
5109046	Detroit	WP1387A	740611M91	Massey-Ferg.	WP293A
5109551	Detroit	WP1388A	78903R91	IHC/Navistar	WP1244
5120882	Detroit	WP1403	7C4957	Caterpillar	WP1006
5123625	Detroit	WP1257A	7C9222	Caterpillar	BP1006
5126877	Detroit	WP1257	7E8554	Caterpillar	WP1011
5135595	Detroit/Oliver	WP1257A	7N5909	Caterpillar	WP1008A
5135596	Detroit	WP1257	7W7019	Caterpillar	WP1006
5144685	Detroit	WP1388	818X13618	Mack	WP799
5144686	Detroit	WP1387	830691M91	Continental	WP1295
5144687	Detroit	WP1387	830862M91	Massey/Cont.	WP1243
5149320	Detroit	TBA	835615M91	Massey-Ferg.	WP287
5149321	Detroit	WP1379	835707M91	Massey-Ferg.	WP288
5149323	Detroit	WP1378	8530514-M91	Continental	WP1295
5149326	Detroit	WP1395	861236R92	IHC/Navistar	WP573S
5149327	Detroit	WP1396A	87512R91	IHC/Navistar	WP132
5149328	Detroit	WP1394	87521R93	IHC	WP131A
5149329	Detroit	WP1396	8875385	Chev./GMC	WP1430
5149330	Detroit	WP1404	8875385	Chev./GMC	WP1436
5149332	Detroit	WP1402	8885837	Chev./GMC	WP1436
5149336	Detroit	WP1401	8885837	Chev./GMC	WP1430
5149381	Detroit	WP1396R	8885838	Chev./GMC	WP575
5149382	Detroit	WP1395R	8920915	Detroit	WP601A
5149706	Detroit	WP1257A	8920916	Detroit	WP601
5149707	Detroit	WP1257	8921104	Detroit	WP1397
5149708	Detroit	WP601	8921105	Detroit	WP1395A
5149710	Detroit	WP601A	8922302	Detroit	WP1399
5149711	Detroit	WP601	8922335	Detroit	WP1397
5150439	Detroit	WP1257A	8922336	Detroit	WP1395A
5159059	Detroit	WP1257A	8927158	Detroit	WP1399A
5159060	Detroit	WP1257	8928672	Detroit	WP1399A

## Cross Reference

### OEM Number to Water Pump Number by Manufacturer

OEM #	Manufacturer	Part #	OEM #	Manufacturer	Part #
8929509	Detroit	WP1400	BM79557	Cummins	WP634
8IZ8501ARM	Ford	WP1577	BM93252	Cummins	WP634
8N-8501	Ford	WP1290	C4AZ-8501A	Ford	WP1519
8RT-8501A	Ford	WP1522	C4TZ-8501A	Ford	WP1415
8RT-8501B	Ford	WP1522	C4TZ-8501B	Ford	WP1416
8RT-8502A	Ford	WP1521	C4TZ-8501C	Ford	WP1415
8RT-8502B	Ford	WP1521	C4TZ-8501D	Ford	WP1416
947544	Chrysler/Mas.	WP580H	C4TZ-8501F	Ford	WP1415
9L7660	Caterpillar	WP1001	C4TZ-8501G	Ford	WP1416
9N1946	Ford Truck	WP1000	C4TZ-8501G	Ford	WP1544
9N3161	Caterpillar	WP1006	C4TZ-8501H	Ford	WP1415
9N5035	Caterpillar	WP1006	C4TZ-8501H	Ford	WP1527
9N6147	Caterpillar	WP1000T	C5AZ-8501C	Ford	WP1515
9N-8501	Ford	WP1290	C5AZ-8501G	Ford	WP1515
9Y4361	Caterpillar	WP1011	C5AZ-8501J	Ford	WP1435
9Y4879	Caterpillar	WP1020	C5AZ-8501M	Ford	WP1515
9Y5646	Caterpillar	WP1006	C5AZ-8501R	Ford	WP1515
A146584	Case	WP302	C5AZ-8501U	Ford	WP1515
A-34079-A05	Cummins	WP667	C5AZ-8501V	Ford	WP1515
A77703	Case	WP682	C5NN-8501A	Ford Agro	WP1474
A77704	Case	WP683	C5NN-8501E	Ford Agro	WP1474A
AR00506	Cummins	WP634A	C5TZ-8501A	Ford	WP1460
AR10637	Cummins	WP641	C5TZ-8501B	Ford	WP1460
AR10787	Cummins	WP645	C5TZ-8501C	Ford	WP1460
AR10961	Cummins	WP680	C6AZ-8501A	Ford	WP1435
AR4283	Cummins	WP632	C6AZ-8501B	Ford	WP1435
AR4284	Cummins	WP632	C6AZ-8501C	Ford	WP1435
AR45073	Cummins	WP646	C6DZ-8501C	Ford Ind.	WP1350
AR45090	Cummins	WP640	C6DZ-8501D	Ford Ind.	WP1350
AR45184	Cummins	WP638	C9NN-8501B	Ford Ind.	WP1350
AR45189	Cummins	IP638	C9NN-8501B	Ford Agro	WP1477
AR4546	Cummins	WP632A	C9TZ-8501A	Ford	WP1502
AR4547	Cummins	WP633A	CDPN-8501C	Ford	WP1291
AR4548	Cummins	WP633	D0AZ-8501A	Ford	WP1515
AR51360	Cummins	WP633B	D0AZ-8501D	Ford	WP1515
AR5664	Cummins	WP670	D0OZ-8501C	Ford	WP1502
AR61116	Cummins	WP668	D0TZ-8501B	Ford	WP1527
AR61788	Cummins	WP667	D1JJ-8501C	Ford	WP1291A
AR8851	Cummins	IP640	D1TZ-8501A	Ford	WP1509
B6C-8501A	Ford	WP1520	D1TZ-8501B	Ford	WP1528
B6C-8501B	Ford	WP1520	D1TZ-8501C	Ford	WP1529
B6C-8501C	Ford	WP1513	D2AZ-8501A	Ford	WP1435
B8Q-8501A	Ford	WP1328	D2TZ-8501A	Ford	WP1509
B8TZ-8501A	Ford	WP1328	D2TZ-8501B	Ford	WP1329A
B8TZ-8501C	Ford	WP1329	D4TZ-8501D	Ford	WP1497
B8TZ-8501C	Ford	WP1328	D4TZ-8501F	Ford	WP1572
BM34948	Cummins	WP741	D4TZ-8501G	Ford	WP1527
BM37859	Cummins	WP635	D4TZ-8501H	Ford	WP1515
BM50345	Cummins	WP631A	D4TZ-8501K	Ford	WP1571
BM50356	Cummins	WP631AA	D4TZ-8501L	Ford	WP1572
BM50446	Cummins	WP630	D4TZ-8501M	Ford	WP1527
BM54327	Cummins	WP630A	D5NN-8501E	Ford Agro	WP1474A
BM62844	Cummins	WP687	D5TZ-8501A	Ford	WP1435
BM62845	Cummins	WP688	D5TZ-8501B	Ford	WP1548
BM71040	Cummins	WP631	D5TZ-8501C	Ford	WP1509
BM76506	Cummins	WP630	D5TZ-8501D	Ford	WP1573
BM76510	Cummins	WP630A	D5TZ-8501E	Ford	WP1569
BM77548	Cummins	WP742	D5TZ-8501F	Ford	WP1574
BM78372	Cummins	WP632	D5TZ-8501G	Ford	WP1535
BM78724	Cummins	WP634	D5UZ-8501A	Ford	WP1502
BM79321	Cummins	WP632A	D6HZ-8501A	Ford	WP1596

## Cross Reference

### OEM Number to Water Pump Number by Manufacturer

OEM #	Manufacturer	Part #	OEM #	Manufacturer	Part #
D6ZZ-8501B	Ford	WP1502	R3505895	Detroit Reman	WP1409
D7HZ-8501C	Ford	WP1518	R3514989	Detroit Reman	WP1400
D7HZ-8501D	Ford	WP1573	R3514990	Detroit Reman	WP1409
D7HZ-8501E	Ford	WP1569	R3520136	Detroit Reman	WP1409
D7HZ-8501F	Ford	WP1574	R4723690	Cummins	WP682
D8HZ-8501A	Ford	WP1574	U5MW0040	Perkins	WP1466
D8HZ-8501B	Ford	WP1580	Y400K-3612	Continental	WP664
D8TZ-8501B	Ford	WP1535	Z120K-3051	Continental	WP1243
D9HZ-8501A	Ford	WP1595	ZGA735327	IHC/Navistar	WP565
DIX-2	Allis Chal.	WP250			
E1HZ-8501DRM	Ford	WP1598			
E2HZ-8501B	Ford	WP1595			
E3TZ-8501C	Ford	WP1511			
E4TZ-8501B	Ford	WP1548			
E4TZ-8501C	Ford	WP560F			
E4TZ8501E	Ford	WP1535			
E5HZ-8501A	Ford	WP1595			
E5TZ-8501C	Ford	WP1535			
E6HZ-8501A	Ford	WP1592			
E6TZ-8501A,BRM	Ford	TBA			
E7HZ-8501A	Ford	WP1594			
E7HZ-8501A	Ford	WP1597			
E7HZ-8501B	Ford	WP1594			
E7TZ-8501A	Ford	WP1597			
E7TZ-8501ARM	Ford	WP1566			
E7TZ-8501B	Ford	WP1510			
E8HZ-8501B	Ford	WP1594			
E8HZ-8501CRM	Ford	WP1597			
E9PZ-8501A	Ford	WP1511			
E9PZ-8501D	Ford	WP1548			
E9TZ-8501B	Ford	WP560F			
EAF-8501C	Ford	WP1291			
F0PZ-8501A	Ford	WP1511			
F0TZ-8501E	Ford	WP1567			
F0TZ-8501F	Ford	WP1510			
F162K-3653	Continental	WP586			
F1HZ-8501C	Ford	WP1599			
F1HZ-8501CRM	Ford	WP1599			
F1HZ-8501D	Ford	WP1598			
F1HZ-8501DRM	Ford	WP1598			
F1HZ-8501E	Ford	WP1595			
F1TZ-8501A	Ford	WP1535			
F2TZ-8501A	Ford	WP1566A			
F2UZ-8501A	Ford	WP1585			
F2UZ-8501C	Ford	WP1584			
F3HZ-8501ARM	Ford Truck	WP682			
F3HZ-8501B	Ford Truck	WP683			
F3HZ-8501BRM	Ford Truck	WP683			
F3TZ-8501C	Ford	WP1567			
F3TZ-8501E	Ford	WP1549			
F4TZ-8501ARM	Ford	WP1579			
F4TZ-8501B	Ford	WP1583			
F5HZ-8501AA	Ford	WP1595			
F5TZ-8501A	Ford	WP1549			
F5TZ-8501A,B,CRM	Ford	WP1581			
F5TZ-8501ARM	Ford	WP1581			
F5TZ-8501BRM	Ford	WP1577			
F600K-4105	Continental	WP578			
F6TE-8501K	Ford	WP1549			
G-11956	Case	WP258			
KS-350A	Oliver	WP268			



# Competitive Cross Reference

Competitor#	Precision#	Competitor#	Precision#	Competitor#	Precision#
<b>Carter/ TRW Continued</b>		<b>Caterpillar</b>		<b>Complete Parts Continued</b>	
FP1885	WP586	1006944	WP1019	WP1170	WP638
FP1886	WP1474	1025844	WP1011	WP1171	WP640
FP1887	WP268	1W4619	WP1013	WP1172	WP636
FP1888	WP287	2W1225	WP1003T	WP1173	IP638
FP1889	WP293A	2W1227	WP1003TF	WP1174	WP632
FP1890	WP1464A	4P9862	TBA	WP1175	IP640
FP1891	WP266	4W0253	WP1020	WP1177	WP638
FP1894	WP1257A	6I3890	WP1016	WP1179	WP646
FP1895	WP269	6N8413	WP1013	WP1180	WP1388
FP1906	WP1478	7C4957	WP1006	WP1181	WP1257
FP1907	WP1477	7C9222	BP1006	WP1182	WP1257A
FP1909	WP664	7E8554	WP1011	WP1183	WP1387
FP1940	WP563A	7N196	WP1013	WP1184	WP1394
FP1945	WP1000	7N5909	WP1008	WP1185	WP1396A
FP1946	WP1006	7W7019	WP1006	WP1186	WP1395
FP1947	WP1395A	9L7660	WP1001	WP1187	WP1396
FP1948	WP1397	9N6147	WP1000T	WP1188	WP1397
FP1949	WP1396A	9N6147	WP1003T	WP1189	WP1395A
FP1951	WP646MG	9Y4361	WP1011	WP1190	WP563A
FP1952	WP646	9Y4879	WP1020	WP1191	WP563
FP1955	WP632	OR0482	WP1006	WP1192	WP601
FP1956	WP636	OR0483	WP1016	WP1193	WP601A
FP1957	WP1394	OR0644	WP1001	WP1194	WP1006
FP1980	WP1592	OR0705	WP1019	WP1195	WP646MG
FP2001	WP638	OR0781	WP1003T	WP1200	WP1199
FP2010	WP1594	OR0796	WP1010	WP1320	WP293A
FP2010	WP1593	OR0797	WP1008	WP1406	WP1623
FP2012	WP1210NP	OR0798	WP1009	WP1409	WP1479
FP2012	WP1219	OR1002	WP1008B	WP1556	WP1601
FP2049	WP563	OR1003	WP1013	WP1559	WP1602
FP2050	WP564	OR1013	WP1020	WP1560	WP1605
FP2063	WP1590	OR1244	WP1003TF	WP1561	WP799
FP2090	WP1628	OR1251	WP1013	WP1562	WP800
FP2090	WP1629	OR1364	WP1008B	WP1569	WP1610
FP2145	WP1585	OR2550	WP1012	WP1575	WP1611
FP2147	WP1584	OR2853	WP1014	WP1705	WP1409
FP2189	WP566	OR3007	WP1020	WP1710	WP1399A
FP2190	WP567	OR3709	WP1019	WP1731	WP564
FP2195	WP1399A	OR3789	WP1006	WP1747	WP560
FP2196	WP1003TF	OR3790	WP1006	WP1757	WP560F
FP2198	WP1599	OR4117	WP1011	WP1760	WP1597
FP2199	WP1598	OR4120	WP1016	WP1765	WP1552
FP2212	WP298	OR4121	WP1016	WP1767	WP299
FP2235	WP288	OR8217	WP1006	WP2000	WP794S
FP2236	WP1464	OR8218E	WP1016	WP2001	WP794BS
FP2237	IP640	OR8354	WP1013	WP2002	WP1210NP
FP2238	WP624	OR8532	TBA	WP2003	WP810
FP2240	WP302	OR8766	WP1011	WP2008	WP1210
FP2241	WP299	OR8767	WP1019	WP2025	WP1016
FP2242	WP601	OR9493	TBA	WP2117	WP1466
FP2243	WP601A	OR9497	WP1013	WP2254	WP637
FP2244	WP1396	OR9785	WP1008B	WP2258	WP671
FP2245	WP633B			WP2257	WP644
FP2247	WP1605			WP2258	IP671
FP2248	WP1000T	<b>Complete Parts</b>		WP2259	IP644
FP2249	IP638	WP1110	WP302	WP2260	WP689
FP2262	WP682	WP1120	WP1200	WP2261	IP689
FP2269	WP1583	WP1135	WP563B		
FP2279	WP638	WP1149	WP1000T	<b>Enduro</b>	
FP2281	WP644	WP1150	WP297	EP3000886X	WP640
FP2282	WP637	WP1151	WP1295	EP3004923X	WP638
FP2283	IP644A	WP1152	WP1464A	EP3027882X	WP646MG
FP2284	IP644	WP1153	WP1464	EP3045943X	WP636
FP2285	WP683	WP1158	WP624	EP316L-CA-X	WP1210NP
		WP1162	WP1003T		







# **SECTION 4**

## **INSTALLATION INSTRUCTIONS**

### **POLICIES**

### **NUMERICAL LISTING**

# Water Pump Installation Instructions

The number one cause of water pump failure is contaminated coolant. To insure long life, it is necessary to follow the procedures listed below.

- 1) Drain and flush the cooling system. Recycle old coolant. Failure to flush system will result in premature seal failure. Water pumps submitted for warranty with seal damage resulting from contaminants in the cooling system will be denied.
- 2) Handle the remanufactured pump with care. If a pulley is to be installed, use shop press and support the rear of the shaft. Do not press against the impeller. Never use a hammer. Impellers that are damaged due to mishandling will not be warranted.
- 3) Check the belts, thermostat, fan, fan clutch, and pulleys. Replace as necessary. Idler pulleys (if so equipped) should always be replaced when installing the replacement water pump.
- 4) Compare the old water pump to the replacement pump to be sure they are the same. Check bolt pattern, impeller size and stand-out from the mounting flange.
- 5) Clean the engine block mounting surface to insure proper gasket seal. Do not use excessive gasket sealing materials. Use an alternate tightening sequence on mounting bolts to insure proper seating and avoid warping. Once the pump has been mounted, make certain that the shaft rotates freely.
- 6) Install belts and tighten to the engine manufacturer's specifications. Do not over-tighten. Properly tightened belts should have 1/2" to 3/4" deflection.
- 7) Connect the hoses and fill with proper coolant. Inspect the entire installation for leaks. **Note:** You may detect a small amount of water coming from a weep hole in the pump right after installation. Run the engine for 30 minutes to an hour to allow the seals to seat and the seepage should stop.

**REMEMBER:**     *Make certain that the shaft turns freely.  
No wobbly or damaged fans or fan clutches.  
Do not over-tighten belts.  
Make a final coolant level check.*

*If you have questions or need assistance, call tech support at 1-800-325-2690*

# Water Pump Warranty Policy

## Water Pump Limited Warranty

Precision Rebuilders, Inc. remanufactured water pumps are guaranteed to be free of defective parts or workmanship for a period of one (1) year from the date of purchase, when such parts are used in strict accordance with the instructions for installation and operation.

### **Exceptions to the above limitations:**

Water pumps submitted for warranty with seal damage resulting from contaminants in the cooling system will be denied. Pumps that are damaged or worn as a result of improper belt tension or parts that are damaged due to mishandling or improper installation will not be warranted.

**All warranty claims must be accompanied with an explanation of why the unit was removed from the vehicle. All units claimed defective should be returned, freight prepaid, within thirty (30) days. After inspection of the unit, a final decision will be made as to whether or not the unit is covered under the terms of this warranty.**

**You may request a report of our findings. We reserve the right to repair, replace, or credit warrantable units. Liability from all causes is limited to the value of the goods sold or furnished.**

**This warranty is in lieu of and excludes all other warranties, expressed or implied, arising by operation of law or otherwise, including any warranty of merchantability or fitness for a purpose, and in no event will Precision Rebuilders be liable for incidental or consequential damages including any damages to the engine or other accessories on the vehicle resulting from malfunction or non-performance of the water pump.**

## Water Pump Core Acceptability Policy

Only cores with the same part number are acceptable for credit against previously purchased water pumps. Cores with broken housings have no value for credit. Cores with broken Pulleys or drive gears will be credited at 60% of core price. There is no penalty for cores with broken impellers.

## Numerical Listing

Part #	Sect/Page	Part #	Sect/Page	Part #	Sect/Page
WP131A	3-5,3-14	WP573	1-14, 3-2, 3-10, 3-12	IP640	1-7, 1-8, 2-7, 3-3, 3-8, 3-13, 3-15, 3-17, 3-18, 3-19, 3-20
WP132	3-5,3-10,3-14	WP573S	1-14, 3-2, 3-10, 3-14	WP640	1-7, 2-12, 3-3, 3-8, 3-13, 3-15, 3-17, 3-18, 3-19, 3-20
WP134	3-2, 3-10, 3-12	WP574	1-15, 3-3, 3-10, 3-12	WP640A	1-7, 2-11, 3-3, 3-8, 3-13
WP139	3-4, 3-10,	WP575	1-5, 3-3, 3-7, 3-12, 3-14, 3-17	WP640C	1-7, 2-12, 3-3, 3-8, 3-17
WP249	3-7	WP578	3-6, 3-8, 3-16	WP641	1-5, 2-9, 3-3, 3-8, 3-15
WP250	3-2, 3-7, 3-16	WP579	3-6, 3-8	WP642	1-5, 2-9, 3-3, 3-8, 3-13, 3-17
WP251	3-2, 3-7, 3-12, 3-17	WP580F	3-2, 3-5, 3-7, 3-8, 3-12, 3-17	IP644	1-8, 2-7, 3-3, 3-8, 3-13, 3-17, 3-18, 3-19, 3-20
WP252	3-6, 3-7	WP580H	3-2, 3-3, 3-5, 3-7, 3-8, 3-12, 3-15, 3-17	IP644A	1-8, 2-7, 3-13, 3-17, 3-18, 3-19, 3-20
WP253	3-7	WP583	3-5, 3-7	IP644B	1-8, 3-3, 3-8, 3-13, 3-17, 3-17, 3-18, 3-19, 3-20
WP258	3-5, 3-6, 3-7, 3-16, 3-17, 3-3, 3-10, 3-13, 3-17	WP584	3-6, 3-8	WP644	1-7, 2-12, 3-3, 3-8, 3-13, 3-17, 3-18, 3-19, 3-20
WP260	3-3, 3-10, 3-13, 3-17	WP585	3-6, 3-8	WP645	1-5, 2-9, 3-3, 3-8, 3-15
WP266	3-7, 3-12, 3-18	WP586	3-6, 3-8, 3-16, 3-18	WP646	1-7, 2-11, 3-3, 3-8, 3-13, 3-15, 3-17, 3-18, 3-19, 3-20
WP268	3-2, 3-11, 3-12, 3-16, 3-18	WP586A	3-6, 3-8	WP646MG	1-7, 2-11, 3-3, 3-8, 3-13, 3-17, 3-18, 3-19, 3-20
WP269	3-2, 3-11, 3-12, 3-18	WP587	3-6, 3-8	WP662	3-6, 3-8
WP272A	1-10, 3-2, 3-9, 3-12	WP587A	3-6, 3-8	WP663	3-6, 3-8
WP276	1-10, 3-2, 3-9, 3-12	WP601	1-9, 2-15, 3-4, 3-5, 3-9, 3-12, 3-14, 3-17, 3-18, 3-19, 3-20	WP664	3-6, 3-8, 3-16, 3-18
WP278	1-10, 3-2, 3-9, 3-12	WP601A	1-9, 2-15, 3-4, 3-5, 3-9, 3-12, 3-14, 3-17, 3-18, 3-19, 3-20	WP667	1-7, 2-13, 3-4, 3-8, 3-15
WP285	3-5, 3-10	WP624	1-17, 3-4, 3-11, 3-14, 3-18	WP668	1-7, 2-13, 3-4, 3-8, 3-15, 3-17
WP286	3-5, 3-10,	WP630	1-5, 2-9, 3-2, 3-8, 3-15, 3-17, 3-20	WP669	1-7, 2-13, 3-3, 3-8, 3-13
WP287	3-6, 3-11, 3-14, 3-18	WP630A	1-5, 2-9, 3-2, 3-8, 3-15, 3-17, 3-20	WP670	1-9, 2-13, 3-2, 3-8, 3-15, 3-17, 3-19, 3-20
WP288	3-6, 3-11, 3-14, 3-18	WP631	1-6, 2-10, 3-2, 3-8, 3-15, 3-17	IP671	1-8, 2-7, 3-3, 3-8, 3-13, 3-18, 3-20
WP289	3-5, 3-10	WP631A	1-6, 2-10, 3-2, 3-8, 3-15, 3-17	WP671	1-6, 2-10, 3-4, 3-8, 3-13, 3-17, 3-18, 3-19, 3-20
WP293	3-2, 3-4, 3-11, 3-14	WP631AA	1-6, 2-10, 3-2, 3-8, 3-15, 3-17	WP673	1-15, 3-4, 3-11, 3-13
WP293A	3-4, 3-11, 3-14, 3-18	WP631AA	1-6, 2-10, 3-2, 3-8, 3-15, 3-17, 3-18, 3-19, 3-20	WP675	1-15, 3-3, 3-11, 3-13
WP298	3-2, 3-11, 3-12, 3-18	WP632	1-6, 2-9, 3-2, 3-8, 3-15, 3-17, 3-18, 3-19, 3-20	WP681	1-5, 2-8, 3-4, 3-8, 3-13, 3-14, 3-17, 3-19, 3-20
WP299	1-17, 3-14, 3-18	WP632A	1-6, 2-9, 3-2, 3-8, 3-15	WP682	1-5, 1-6, 1-12, 2-8, 2-18, 3-4, 3-8, 3-13, 3-15, 3-16, 3-17, 3-18, 3-19
WP302	3-6, 3-7, 3-15, 3-18	WP633	1-6, 2-10, 3-2, 3-8, 3-15, 3-17, 3-19, 3-20	WP683	1-5, 1-12, 2-8, 2-18, 3-4, 3-8, 3-13, 3-15, 3-16, 3-17, 3-18, 3-19, 3-20
WP305	3-4, 3-7	WP633A	1-6, 2-10, 3-2, 3-8, 3-15, 3-17, 3-19, 3-20	WP684	1-6, 2-11, 3-3, 3-8, 3-13, 3-17, 3-19, 3-20
WP307	3-6, 3-7	WP633B	1-6, 2-10, 3-2, 3-8, 3-15, 3-18, 3-20	WP685	2-8
WP405	3-6, 3-10	WP634	1-7, 3-2, 3-8, 3-15	WP687	1-7, 3-2, 3-8, 3-15
WP406	3-6, 3-10,	WP634A	1-7, 3-2, 3-8, 3-15	WP688	1-7, 3-2, 3-8, 3-15
WP407	3-6, 3-10	WP635	1-5, 3-2, 3-8, 3-15	IP689	1-8, 2-7, 3-3, 3-8, 3-13, 3-17, 3-18, 3-19, 3-20
WP408	3-6, 3-10	WP636	1-7, 2-13, 3-3, 3-8, 3-13, 3-17, 3-18, 3-19, 3-20	WP689	1-7, 2-12, 3-3, 3-8, 3-13, 3-17, 3-18, 3-19, 3-20
WP415	3-6, 3-10	IP637	1-8, 2-7, 3-3, 3-8, 3-13, 3-17, 3-19	WP689A	1-7
WP416	3-6, 3-10	WP637	1-6, 2-10, 3-3, 3-8, 3-13, 3-17, 3-18, 3-19, 3-20	WP739	1-6, 3-2, 3-8, 3-13, 3-17
WP425	3-4, 3-10	WP637	1-6, 2-10, 3-3, 3-8, 3-13, 3-17, 3-18, 3-19, 3-20	WP740	1-5, 3-2, 3-8, 3-12
WP426	3-6, 3-10	IP638	1-6, 1-8, 2-7, 2-11, 2-12, 3-3, 3-8, 3-13, 3-15, 3-17, 3-18, 3-19, 3-20	WP741	1-5, 3-2, 3-8, 3-15
WP430	3-6, 3-10	WP638	1-6, 2-11, 2-12, 3-3, 3-8, 3-13, 3-15, 3-17, 3-18, 3-19, 3-20	WP741A	1-5, 3-2, 3-8
WP431	3-6, 3-10	WP638A	2-11, 3-8, 3-20	WP742	1-5, 3-2, 3-8, 3-15
WP432	3-6, 3-10	WP638B	1-5, 2-8, 3-3, 3-8,	WP787	1-16, 3-3, 3-11, 3-13
WP433	3-6, 3-10	WP638C	1-6, 2-11, 3-3, 3-8, 3-19	WP789	1-15, 3-4, 3-11, 3-13
WP434	3-6, 3-10, 3-11	WP639	1-5, 2-8, 3-3, 3-8, 3-13, 3-17	WP790	1-15, 3-5, 3-11, 3-13
WP435	3-6, 3-10, 3-11				
WP442	1-4, 3-3, 3-4, 3-7, 3-11, 3-12, 3-13, 3-17				
WP528	1-16, 2-22,				
WP528	2-22, 3-3, 3-4, 3-11, 3-13, 3-17, 3-19				
WP550	1-14, 3-2, 3-10, 3-13, 3-17				
WP559	1-15, 2-20, 3-2, 3-10, 3-12, 3-17, 3-19				
WP560	1-14, 2-19, 3-4, 3-10, 3-12, 3-17, 3-18, 3-19, 3-20				
WP560F	1-11, 2-17, 3-4, 3-9, 3-16, 3-17, 3-18, 3-19, 3-20				
WP563	1-14, 1-15, 2-19, 3-5, 3-10, 3-14, 3-17, 3-18, 3-19, 3-20				
WP563A	1-15, 2-19, 3-5, 3-10, 3-14, 3-17, 3-18, 3-19, 3-20				
WP563B	3-5, 3-10, 3-14, 3-17, 3-18, 3-19, 3-20				
WP563C	3-5, 3-10, 3-14, 3-17				
WP564	3-3, 3-10, 3-13, 3-18				
WP565	1-15, 2-19, 3-5, 3-10, 3-12, 3-14, 3-16, 3-17, 3-19, 3-20				
WP566	3-3, 3-10, 3-13, 3-18				
WP567	3-3, 3-10, 3-13, 3-18				
WP568	1-15, 2-20, 3-2, 3-10, 3-12, 3-17, 3-19, 3-20				
WP571	1-15, 3-2, 3-3, 3-10, 3-13, 3-14, 3-17				

## Numerical Listing

<b>Part #</b>	<b>Sect/Page</b>	<b>Part #</b>	<b>Sect/Page</b>	<b>Part #</b>	<b>Sect/Page</b>
WP790A	1-15, 3-5, 3-11, 3-13	WP1210NP	1-16, 2-22, 3-4, 3-17, 3-18, 3-19, 3-20	WP1399	1-6, 2-14, 2-14, 3-5, 3-9, 3-14, 3-17, 3-19, 3-20,
WP791	1-15, 3-5, 3-11, 3-13	WP1211	1-16, 2-21, 3-3, 3-4, 3-11, 3-13, 3-17, 3-19, 3-20	WP1399A	1-8, 2-14, 3-4, 3-5, 3-14, 3-17, 3-18, 3-20
WP792	1-15, 3-5, 3-11, 3-13	WP1219	1-16, 2-22, 3-3, 3-4, 3-11, 3-13, 3-17, 3-18, 3-19, 3-20	WP1400	1-8, 2-14, 3-3, 3-5, 3-8, 3-9, 3-12, 3-15, 3-16, 3-17, 3-19, 3-20
WP793	1-15, 3-5, 3-11, 3-13	WP1227	1-16, 3-3, 3-11, 3-13, 3-17	WP1401	1-9, 3-4, 3-9, 3-14
WP794	1-15, 2-21, 3-3, 3-11, 3-13, 3-17, 3-19, 3-20	WP1228	1-16, 3-3, 3-11, 3-13, 3-17	WP1402	1-9, 3-4, 3-9, 3-14
WP794A	1-16, 3-3, 3-11, 3-13, 3-19	WP1229	1-16, 2-22, 3-4, 3-11, 3-13, 3-17	WP1403	1-8, 3-4, 3-9, 3-14
WP794B	1-16, 2-21, 3-3, 3-4, 3-11, 3-13, 3-17, 3-19, 3-20	WP1230	1-16, 2-22, 3-3, 3-11, 3-13, 3-17	WP1404	1-9, 3-4, 3-9, 3-14
WP794BS	1-16, 2-21, 3-3, 3-4, 3-11, 3-13, 3-17, 3-18, 3-19, 3-20	WP1232	1-16, 2-22, 3-3, 3-11, -13, 3-17	WP1408	1-8, 2-14, 3-3, 3-9, 3-12, 3-17, 3-19
WP794S	1-15, 2-21, 3-3, 3-11, 3-17, 3-18, 3-20	WP1233	1-16, 2-23, 3-3, 3-11, 3-13, 3-17	WP1409	1-8, 2-14, 3-3, 3-9, 3-12, 3-16, 3-17, 3-18, 3-19, 3-20
WP794WH	1-15, 2-21, 3-3, 3-11, 3-13, 3-17	WP1234	1-16, 2-23, 3-3, 3-11, 3-13, 3-17	WP1415	1-12, 3-5, 3-9, 3-15, 3-17
WP795	1-16, 3-3, 3-11, 3-13	WP1236	1-16, 2-23, 3-3, 3-11, 3-13, 3-17	WP1416	1-11, 1-13, 3-5, 3-9, 3-15, 3-17
WP797	1-15, 3-3, 3-11, 3-13	WP1237	1-16, 2-23, 3-3, 3-11, 3-13, 3-17	WP1430	1-4, 3-3, 3-4, 3-7, 3-12, 3-14, 3-17
WP798	1-15, 3-3, 3-11, 3-13	WP1243	3-2, 3-11, 3-14, 3-16, 3-17	WP1435	1-14, 3-5, 3-9, 3-15, 3-17
WP799	1-15, 3-2, 3-11, 3-14, 3-18	WP1244	1-14, 3-5, 3-10	WP1436	1-4, 3-3, 3-4, 3-7, 3-12, 3-14
WP800	1-15, 3-18	WP1244A	1-14, 3-2, 3-10, 3-12, 3-17	WP1440	3-3, 3-8, 3-13, 3-17
WP810	1-16, 3-4, 3-11, 3-13, 3-14, 3-18	WP1257	1-9, 2-15, 3-4, 3-5, 3-9, 3-12	WP1446	1-4, 3-4, 3-7, 3-14, 3-17
WP811	1-16, 3-4, 3-11, 3-14	WP1257A	1-9, 2-15, 3-4, 3-9, 3-14, 3-17, 3-18, 3-19, 3-20	WP1447	3-2, 3-7
WP812	1-16, 3-4, 3-11, 3-14	WP1284	3-2, 3-11, 3-12, 3-17	WP1448	3-4, 3-7
WP1000	1-2, 1-11, 3-2, 3-5, 3-7, 3-15, 3-17, 3-18	WP1290	3-5, 3-10, 3-12, 3-15, 3-17	WP1450	3-2, 3-7
WP1000T	1-2, 2-4, 3-5, 3-7, 3-15, 3-17, 3-18	WP1291	3-6, 3-10	WP1460	1-11, 3-5, 3-9, 3-15, 3-17
WP1001	1-2, 2-2, 3-5, 3-7, 3-15, 3-17, 3-18, 3-19, 3-20	WP1291A	3-15, 3-17	WP1461	1-17, 3-4, 3-11, 3-14
WP1006	1-2, 1-3, 2-6, 3-2, 3-4, 3-5, 3-7, 3-12, 3-14, 3-15, 3-17, 3-18, 3-19, 3-20	WP1295	3-6, 3-8, 3-14, 3-17, 3-18	WP1461A	1-17, 3-4, 3-11
WP1008	1-2, 2-4, 3-3, 3-7, 3-12, 3-17, 3-18	WP1328	1-13, 3-5, 3-6, 3-9, 3-10, 3-15, 3-17	WP1462	1-17, 3-4, 3-11, 3-14
WP1008A	1-2, 2-5, 3-2, 3-7, 3-14	WP1329	1-13, 3-5, 3-6, 3-9, 3-10	WP1463	3-4, 3-11
WP1008B	1-2, 2-4, 2-5, 3-2, 3-3, 3-7, 3-12, 3-14, 3-17, 3-18	WP1329A	1-13, 3-5, 3-9, 3-15, 3-17	WP1464	1-17, 3-4, 3-11, 3-14, 3-18
WP1009	1-3, 3-4, 3-7, 3-14, 3-18, 3-19	WP1349	3-3, 3-4, 3-8, 3-12, 3-13, 3-5, 3-10, 3-15, 3-17	WP1464A	1-17, 3-4, 3-11, 3-14, 3-18
WP1010	1-2, 2-4, 3-5, 3-7, 3-12, 3-18	WP1350	3-5, 3-10, 3-15, 3-17	WP1465	1-17, 3-4, 3-11
WP1011	1-2,	WP1351	3-3, 3-8, 3-13, 3-17	WP1466	1-17, 3-4, 3-11, 3-16, 3-20
WP1012	2-3, 3-2, 3-5, 3-7, 3-12, 3-14, 3-15, 3-17, 3-18, 3-19, 3-20	WP1378	1-9, 3-4, 3-9, 3-14	WP1474	3-5, 3-10, 3-15, 3-18
WP1013	1-2, 2-5, 3-2, 3-5, 3-7, 3-12, 3-14, 3-17, 3-18	WP1379	1-9, 3-4, 3-9, 3-14, 3-17	WP1474A	3-5, 3-10, 3-15, 3-17
WP1014	1-2, 3-2, 3-7, 3-12, 3-18	WP1387	1-8, 2-14, 3-4, 3-9, 3-12	WP1477	3-5, 3-10, 3-15, 3-18
WP1015	1-2, 3-7, 3-14	WP1387A	1-8, 2-14, 3-4, 3-9, 3-14	WP1478	1-14, 3-3, 3-10, 3-14, 3-18, 3-20
WP1016	1-3, 2-6, 3-2, 3-5, 3-7, 3-12, 3-14, 3-17, 3-18, 3-19, 3-20	WP1388	1-8, 2-14, 3-4, 3-9, 3-12	WP1478NP	1-14, 3-3, 3-10, 3-12, 3-17, 3-20
WP1017	1-3, 2-6	WP1388A	1-8, 2-14, 3-4, 3-9, 3-14	WP1479	1-14, 2-19, 3-4, 3-10, 3-12, 3-17, 3-18, 3-19, 3-20
WP1018	2-3	WP1394	1-9, 2-16, 3-4, 3-9, 3-12, 3-14, 3-17, 3-18, 3-19, 3-20	WP1496	3-3, 3-8, 3-12, 3-17
WP1019	1-2, 1-3, 2-3, 3-2, 3-7, 3-12, 3-17, 3-18	WP1395	1-9, 1-10, 2-16, 3-4, 3-5, 3-9, 3-12, 3-14, 3-17, 3-18, 3-19	WP1497	1-14, 3-5, 3-9, 3-15, 3-17
WP1020	1-2, 2-2, 3-4, 3-7, 3-14, 3-15, 3-14, 3-18	WP1395A	1-10, 2-16, 3-4, 3-5, 3-9, 3-12, 3-14, 3-17, 3-18, 3-19	WP1500	1-4, 3-4, 3-7, 3-11, 3-12, 3-14, 3-14, 3-17
WP1021	1-2, 2-2, 3-4, 3-7, 3-17	WP1395AR	1-10, 2-15	WP1501	1-3, 3-4, 3-7, 3-12, 3-13, 3-17
WP1184	1-16, 2-21, 2-22, 3-3, 3-4, 3-11, 3-13, 3-17, 3-18, 3-19, 3-20	WP1395R	1-9, 4-5, 2-16, 3-4, 3-9, 3-12, 3-14, 3-17, 3-19	WP1502	1-10, 3-5, 3-6, 3-9, 3-10, 3-15, 3-16
WP1184B	1-16, 2-22, 3-3, 3-4, 3-11, 3-13, 3-17	3-19		WP1509	1-12, 3-5, 3-9, 3-15, 3-17
WP1199	1-17, 2-23, 3-5, 3-6, 3-11, 3-12, 3-17, 3-18, 3-19, 3-20	WP1396	1-9, 2-16, 3-4, 3-9, 3-12, 3-14, 3-17, 3-18, 3-19	WP1510	1-10, 3-6, 3-10, 3-16
WP1200	1-17, 2-23, 3-6, 3-11, 3-12, 3-17, 3-18, 3-19, 3-20	WP1396A	1-9, 2-16, 3-4, 3-9, 3-12, 3-14, 3-17, 3-18	WP1511	1-10, 3-3, 3-5, 3-6, 3-9, 3-10, 3-16
WP1201	1-17, 3-19	WP1396R	1-9, 2-16, 3-4, 3-9, 3-12, 3-14, 3-17, 3-19, 3-20	WP1513	1-13, 3-5, 3-6, 3-9, 3-10, 3-15, 3-17
WP1210	1-16, 2-22, 3-3, 3-4, 3-11, 3-13, 3-17, 3-18, 3-19, 3-20	WP1397	1-10, 2-16, 3-4, 3-5, 3-9, 3-12, 3-14, 3-17, 3-18, 3-19, 3-20	WP1515	1-13, 3-5, 3-9, 3-15, 3-17

## Numerical Listing

<b>Part #</b>	<b>Sect/Page</b>	<b>Part #</b>	<b>Sect/Page</b>	<b>Part #</b>	<b>Sect/Page</b>
WP1529	1-13, 3-5, 3-9, 3-15, 3-17	WP1623	1-3, 3-2, 3-7, 3-12, 3-17, 3-18, 3-19, 3-20		
WP1533	1-4, 3-2, 3-5, 3-7, 3-12	WP1624	1-4, 3-3, 3-4, 3-7, 3-13, 3-14, 3-17		
WP1534	1-4, 3-3, 3-7, 3-12, 3-14, 3-17	WP1625	1-4, 3-3, 3-4, 3-7, 3-13, 3-14, 3-17		
WP1535	1-11, 3-5, 3-6, 3-9, 3-10, 3-15, 3-16	WP1626	1-3, 3-2, 3-7, 3-12		
WP1544	1-11, 3-5, 3-9, 3-15, 3-17	WP1627	1-3, 1-4, 3-2, 3-7, 3-12		
WP1548	1-10, 1-14, 3-5, 3-6, 3-9, 3-10, 3-15, 3-16	WP1629	1-3, 3-3, 3-7, 3-12, 3-18		
WP1549	1-10, 3-6, 3-10, 3-16	WP1630	1-4, 3-4, 3-5, 3-7, 3-12, 3-14		
WP1552	1-14, 3-2, 3-10, 3-12, 3-14, 3-17, 3-18	WP1633	1-4, 3-3, 3-4, 3-7, 3-11, 3-13, 3-14, 3-17		
WP1566	1-11, 2-17, 3-2, 3-9, 3-10, 3-16, 3-17	WP1635	1-3, 3-2, 3-7, 3-12		
WP1566A	1-11, 3-6, 3-16	WP1639	1-3, 1-4, 3-2, 3-7, 3-12		
WP1567	1-10, 3-6, 3-10, 3-16	WP1640	1-3, 3-2, 3-7, 3-12		
WP1569	1-12, 3-5, 3-10, 3-15, 3-16, 3-17, 3-18				
WP1571	1-12, 3-5, 3-9, 3-15, 3-17				
WP1572	1-13, 3-5, 3-9, 3-15, 3-17				
WP1573	1-12, 3-5, 3-10, 3-15, 3-16, 3-17				
WP1574	1-13, 3-6, 3-6, 3-9, 3-10, 3-15, 3-16, 3-17				
WP1575	1-3, 3-2, 3-4, 3-7, 3-12, 3-14, 3-17, 3-18				
WP1576	1-11, 2-17				
WP1577	1-11, 2-17, 3-2, 3-9, 3-15, 3-16, 3-17, 3-20				
WP1578	1-4, 3-2, 3-7, 3-13				
WP1579	1-11, 2-17, 3-2, 3-10, 3-16, 3-17, 3-20				
WP1580	1-13, 3-5, 3-9, 3-16, 3-17				
WP1581	1-11, 2-17, 3-2, 3-10, 3-16, 3-17				
WP1583	1-11, 3-6, 3-10, 3-16, 3-18				
WP1584	1-11, 3-6, 3-10, 3-16, 3-18				
WP1585	1-10, 3-6, 3-10, 3-16, 3-18				
WP1589	1-13, 3-6, 3-10				
WP1590	1-4, 3-2, 3-7, 3-12, 3-17, 3-18, 3-19				
WP1591	1-5, 3-2, 3-7, 3-12, 3-17, 3-19				
WP1592	1-13, 3-3, 3-9, 3-16, 3-18				
WP1593	1-12, 2-18, 3-6, 3-10, 3-18				
WP1594	1-12, 2-18, 3-6, 3-10, 3-16, 3-17, 3-18, 3-19				
WP1595	1-12, 2-18, 3-6, 3-10, 3-16, 3-17				
WP1596	1-13, 3-5, 3-9, 3-15, 3-17				
WP1597	1-13, 2-18, 3-6, 3-10, 3-16, 3-17, 3-18, 3-19				
WP1598	1-12, 2-18, 3-6, 3-10, 3-16, 3-17, 3-18, 3-19, 3-20				
WP1599	1-12, 2-18, 3-6, 3-10, 3-16, 3-17, 3-18, 3-19				
WP1601	1-17, 3-3, 3-11, 3-13, 3-18, 3-19				
WP1602	1-17, 3-3, 3-11, 3-13, 3-18, 3-19				
WP1605	1-17, 3-2, 3-5, 3-11, 3-12, 3-18, 3-19				
WP1610	1-18, 3-14, 3-18, 3-19, 3-20				
WP1611	1-18, 3-14, 3-18, 3-19				



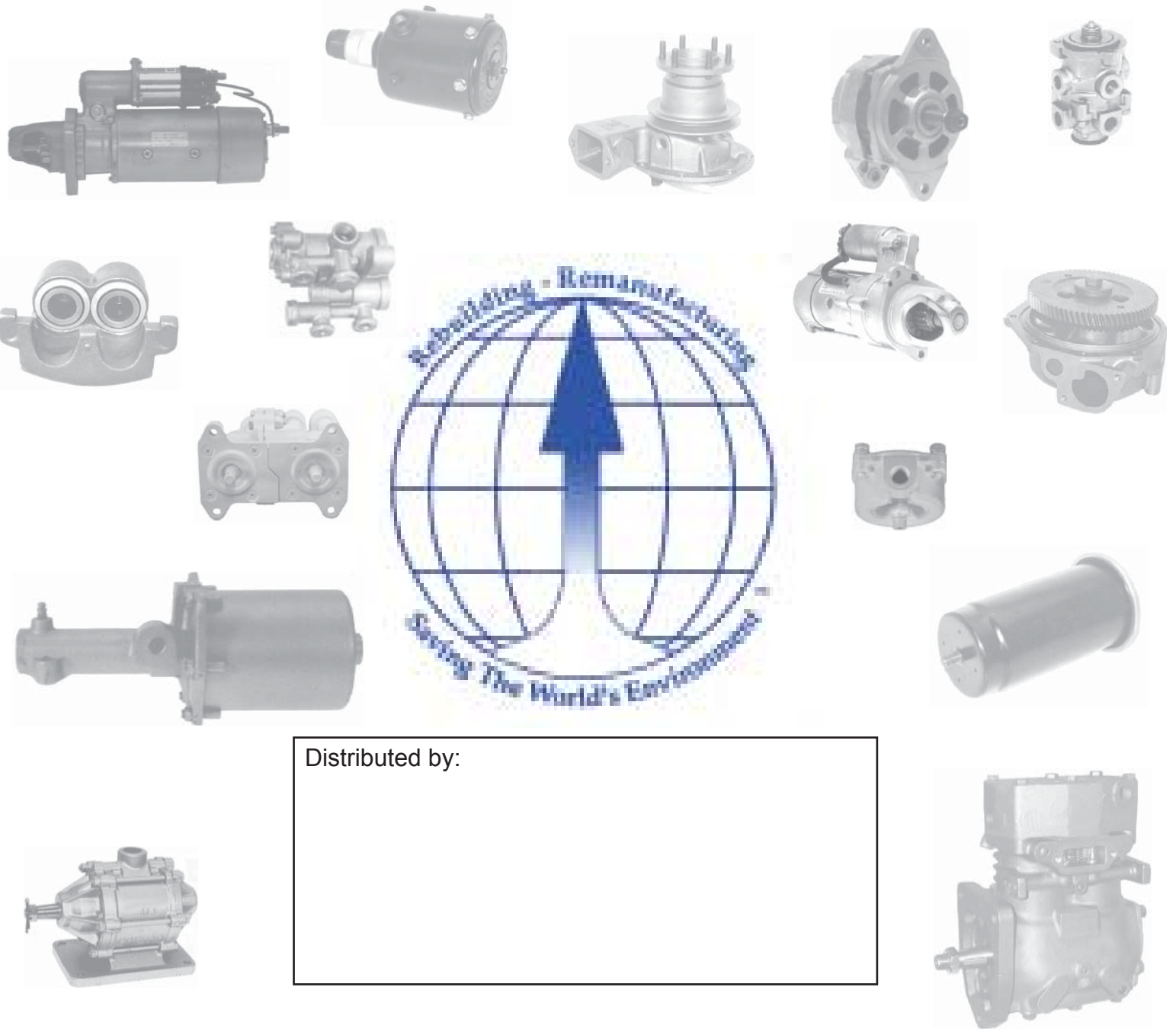

Distributed by:

**Toll Free: 1-800-325-2690**  
**Missouri: 636-629-1444 Fax: 1-800-973-6260**

**350 North Commercial, St. Clair, MO 63077**  
**Website: [www.precisionrebuilders.com](http://www.precisionrebuilders.com)**

**PRECISION  
REBUILDERS**